

Multilift Mobile

**Vertical
Platform Lift**

**Owner's
Manual**

© savaria®

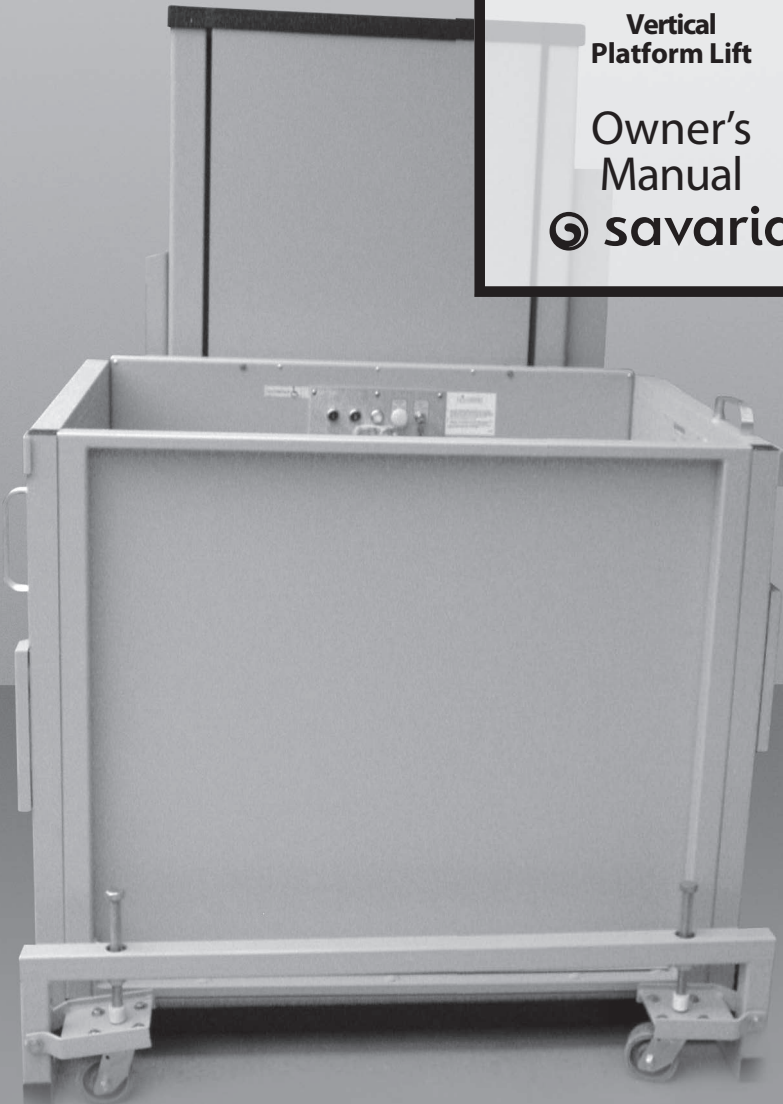

IMPORTANT

Ensure that only an authorized Savaria Dealer installs and services the Savaria® Multilift Mobile. Under no circumstances is anyone other than a dealer with Savaria training and authorization to install, adjust, service or modify any mechanical or electrical device on this equipment. Failure to follow this warning can result in safety system compromises or defeat; this can result in serious injury or death. Savaria accepts no liability for property damage, warranty claims or personal injury, including death, in this circumstance.

Passenger safety is the result of countless details in the equipment's design, manufacture, and installation. After installation, reliable operation and continual safe operation requires regular service and inspection at least twice per year, or more frequently where usage, environment, or local jurisdiction requires. As the Owner, you are responsible for ensuring that regular service and inspections occur in a timely manner.

Refer to this manual for specifications, operating instructions and maintenance of the Savaria® Multilift Mobile.

Upon completion of installation, the dealer must provide you with the following information and ensure it is recorded in this manual. In addition, either the dealer or you must keep any service and/or maintenance records in the Maintenance Record section of this manual.

WARRANTY

Ensure your Savaria Dealer provides you with a copy of the manufacturer's limited parts warranty and documentation relating to any Dealer labour warranty.

FOR OWNER'S RECORDS

Customer Name: _____

Installing Dealer: _____

Dealer's Telephone Number: _____

Date Installed: _____

Serial/Job Number: _____

Table of Contents

TO ENSURE SAFE OPERATION	4
1. DESCRIPTION	5
2. GENERAL SPECIFICATIONS	6
3. OPERATION	7
Lower Wheels and Roll Lift Into Position	7
Adjust Upper Limit Switch	9
Operate the Lift	11
Store the Lift	12
4. SAFETY FEATURES	13
Platform Gate	13
Safety Underpan	13
Gate Lock	14
Emergency Stop Button	15
Emergency Manual Lowering	15
5. MAINTENANCE	16
Maintenance Schedule	16
Operator Troubleshooting	17
Maintenance Record	19

TO ENSURE SAFE OPERATION

To ensure safe operation of this equipment, pay careful attention to the important notes below.

- Read this manual carefully before using the equipment.
- To prevent accidents, adhere strictly to the instructions and keep clear of moving parts at all times.
- Follow instructions on all equipment labels at all times. Replace any damaged labels immediately.
- Ensure that only qualified personnel perform maintenance and service on the unit.
- When replacing parts, be sure that only genuine Savaria parts are used.
- This unit is intended for use by a mature person who understands its proper operation as set out in this manual.
- Prior to operation, make sure that:
 - All doors and gates are locked and secure.
 - All areas in and around the lift are clear of any obstructions.
 - All lights are functioning properly.
- Test your keys and emergency stop button every month.

1. DESCRIPTION

Figure 1 shows the Multilift Mobile.

Figure 1



2. GENERAL SPECIFICATIONS

Multilift Mobile Specifications

Applications	Residential (indoor/outdoor); commercial (U.S.A.)
Load capacity	750 lb (340 kg)
Maximum travel	48" (1219 mm)
Levels serviced	2
Travel speed	8 ft/min (0.04 m/s)
Daily cycle	Normal: 10 Heavy: 25 Excessive: 40 Maximum starts in 1 hour on standard installation: 10
Platform size	36" x 48" (914 mm x 1219 mm)
Side guard panels	42" (1067 mm) side guard panels on platform
Cab access	Front/rear access (platform Type 2)
Power supply	120 VAC, 20 A, 60 Hz, single phase
Drive system	Acme screw and back-up nut 1 hp (0.75 Kw) motor, 110 VAC
Control system	Electronic-free relay logic controller
Finish	Beige electrostatic powder coat paint on all steel surfaces and vacuum-formed plastics
Features	Landing station call/send control buttons Continuous-pressure type buttons Car operating panel (COP) control buttons Manual lowering/raising device Low-voltage controls Underpan sensors Non-skid platform surface Automatic access ramp Emergency stop button on COP Disconnect switch on tower

3. OPERATION

Lower Wheels and Roll Lift Into Position

- 1 Lower the four lift wheels. For each wheel, place the hand crank on the wheel bolt and turn the crank to lower the wheels down to the floor.



Figure 2

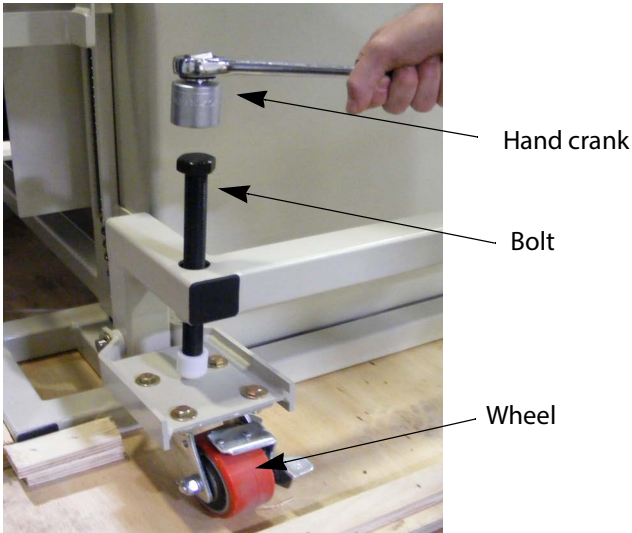

- Roll lift into position at the landing level where it will be used. Using the handcrank, raise the wheels off the floor and ensure the plate above each wheel is activating the push button switch as shown below. Lock down the wheels as shown in the next figure.



Figure 3

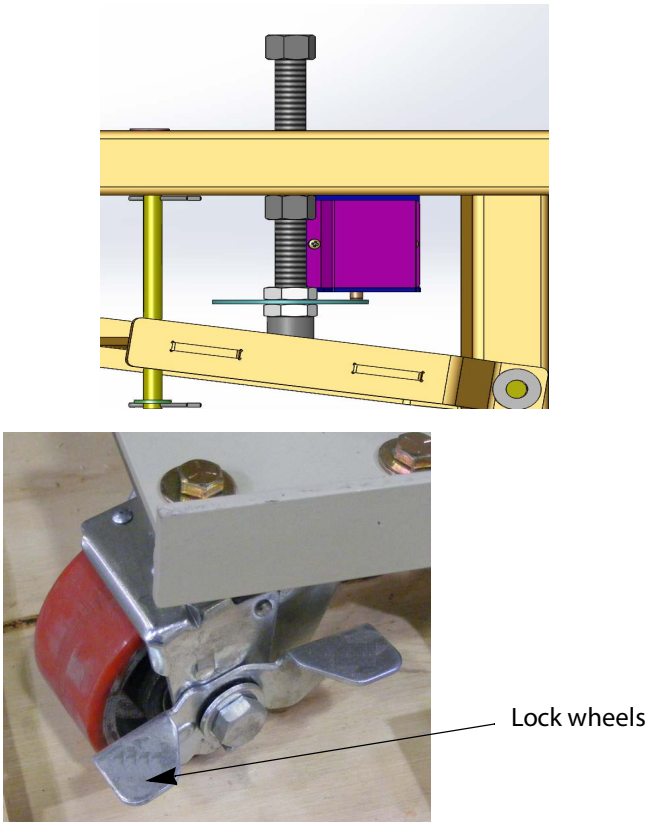

- Ensure that the running clearance between the landing and the platform is 1/2" (12.7 mm).

Adjust Upper Limit Switch

- 1** Remove the switch positioning bar from its storage bracket and place it horizontally on the landing floor. See Figure 4 on the next page.
- 2** Rotate the limit switch handle counter-clockwise to loosen the entire switch assembly.
- 3** Slide the switch assembly down the track so the vertical bar of the switch assembly lines up with the switch positioning bar you placed on the landing floor.
- 4** Tighten the handle to secure the limit switch in place
- 5** Return the switch positioning bar to its storage bracket.

Figure 4

Rotate limit switch handle
CCW and slide assembly
up or down to adjust
limit switch position

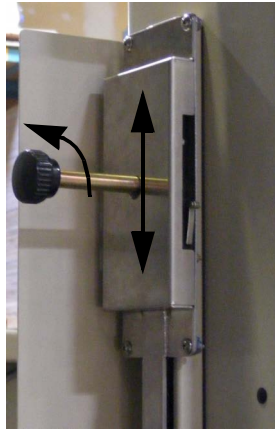

Limit switch cam

Switch positioning bar
in storage position

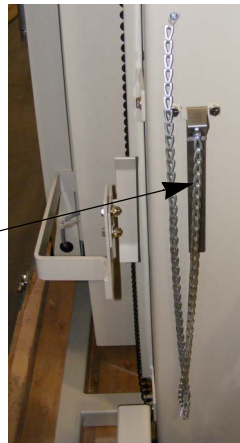

Vertical bar of
switch assembly

Place switch positioning
bar on floor at landing



Operate the Lift

Figure 5 shows the landing station (hall call) controls.

Figure 5

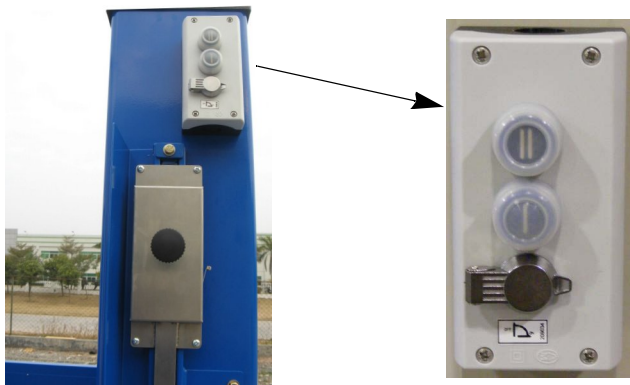

WARNING

Ensure the wheels are locked before operating the lift.

To operate the Multilift Mobile from the landing (call/send) station controls:

- 1** If necessary, call the lift to the landing where you will board.
 - a** Insert the key into the call station and turn it to the operating position.
Note that the key is in the operating position when it cannot be pulled out.
 - b** Press and hold the appropriate button to call the platform to the landing where you will board the lift. Note that the lift will not move if one of the gates is open.
- 3** When the lift arrives at the landing where you will board, the gate will unlock and open automatically. If you need to reopen the gate after the gate open delay is over, turn the key on and press the call button once again to unlock and open the gate.
- 4** Board the lift and insert the key into the key switch on the cab operating panel (COP). See the illustration on the next page.
- 5** Press and hold the appropriate landing button (1 or 2) to move the lift to the desired landing.

- 6 When the lift arrives at the desired landing, the gate will unlock and open automatically.
- 7 To prevent unauthorized use of the lift, take the key out when the unit is not in operation.

Figure 6



Key switch: Turn on to activate landing buttons (1 or 2)

Landing buttons (I or II): Press to move platform to desired landing 1 or 2

Emergency stop: Press to stop the platform immediately (overrides the call stations and sounds the alarm)

Alarm button: Press to activate alarm

NOTE

Pressing the Emergency Stop button during travel will stop the lift immediately and activate the alarm (if equipped). The Emergency Stop overrides the landing station controls. Pull the Emergency Stop out to return the lift to normal operation.

Storing the Lift

Perform the following steps if you need to store the mobile lift.

- 1 Ensure the platform is at the floor level and unplug the power cord.
- 2 Unlock the wheels and roll the lift to the storage location.
- 3 If required, raise the four lift wheels. For each wheel, place the hand crank on the wheel bolt and turn the crank to raise the wheels up off the floor.

4. SAFETY FEATURES

Platform Gate

The platform gate (shown in Figure 7) prevents the passenger from falling off the lift.

Figure 7



Safety Underpan

The safety underpan (shown in Figure 8) is located under the platform. The underpan has sensors that detect any obstacles and stop the downward travel of the lift.

Figure 8

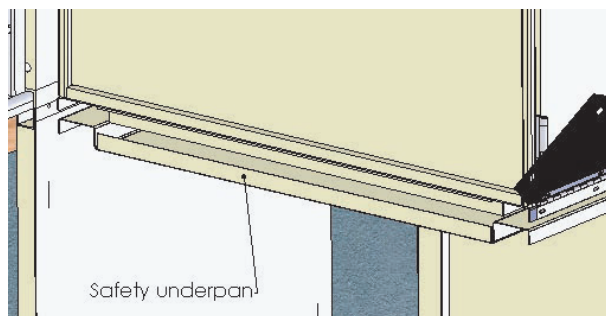

Gate Lock

The WR-500 lock keeps the gate locked when the platform is moving and not at a landing.

NOTE

Keys are for emergency use only and should always be kept in a safe place for use by trained personnel only.

Emergency Gate Opening

The gate can be opened manually using the WR-500 lock emergency key provided (Figure 9).

Insert the key into the lock and turn it a half turn clockwise to unlock the gate. Pull the gate open and then turn the key a half turn counter-clockwise to remove it from the lock.

Figure 9

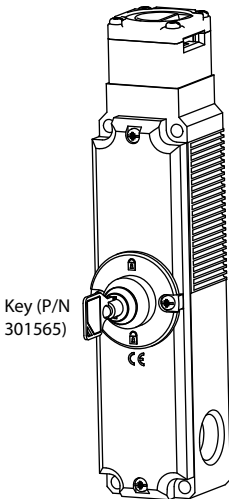

Emergency Stop Button

Pressing the red Emergency Stop button during travel will stop the lift immediately and activate the alarm. The Emergency Stop overrides the landing stations controls. To return the lift to normal operation, pull out the Emergency Stop button.

Disconnect Switch

There is a red Disconnect Switch on the back of the tower in the top left corner. Turning this switch to the OFF position cuts off power to the lift. The switch must be in the ON position for normal operation of the lift.



Emergency Manual Lowering

In an emergency situation, you can lower the platform manually using the hand crank provided (Figure 10).

- 1 Take off the cap and insert the hand crank as shown in Figure 9.
- 2 Turn the hand crank to move the platform to the desired position at the lower landing.
- 3 Remove the hand crank and put the cap back on.

NOTE

This mechanism is for emergency use only.

Figure 10

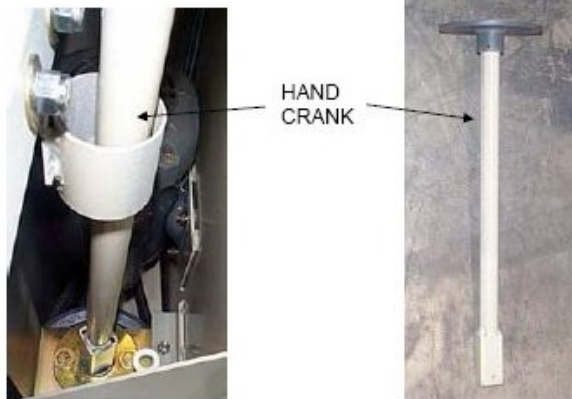

5. MAINTENANCE

NOTE

Regular maintenance (performed by your Authorized Savaria Dealer) will keep your unit in proper operating condition. As the owner of this unit, you are responsible for making sure that maintenance and upkeep are done on a regularly scheduled basis. To ensure proper operating condition of your unit, the items listed below must be performed every 6 months by an Authorized Savaria Dealer.

Additional inspections may be required depending on usage.

Units installed in adverse environments will require additional maintenance on a monthly basis

Maintenance Schedule

VERIFICATION BY TECHNICIAN ONLY	Frequency
Verify the following: <ul style="list-style-type: none"> • General operation of the lift • Operation of the underpan sensors • Operation of the emergency stop button • Operation of the gate lock contacts. The lift should not run unless the gate is closed and locked. 	Every 6 months
Verify the safety components: <ul style="list-style-type: none"> • Operation and alignment of the up final limit switch (activate by hand) • Operation of the back-up nut switch • Operation of the load switch. Lower the platform to the ground using the hand crank in order to release the load on the main nut. The lift should not run up until you restore the load on the main nut by moving the platform up with the hand crank. • Operation of the up relays. Verify that neither of the two up relays gets stuck in the activated position. Use a multimeter to verify that every N.O. contact is open when the relays are not activated. 	Every 6 months
Verify that all hardware is tightened.	Every 6 months
Check the rollers and battery charge	Every 6 months
Lubricate the acme screw and upper bearing using high-quality wheel bearing grease.	Every 6 months

Operator Troubleshooting

The following table lists potential problems and their possible solutions.

If the problem persists, contact your Authorized Dealer.

Potential Problem	Possible Solution
Platform travels up but not down	Check the underpan sensor operation. Pull down on the underpan to ensure the pan is not stuck in the activated position.
Platform travels down but not up	Check the power supply (breaker, cord, battery, etc.)
Platform does not move in either direction	Check that the key is ON (if applicable). Check that the gates are closed. Check to see if the Emergency Stop button is pushed in; it should be pulled out for normal operation. If the platform is at the top landing, check the underpan sensor as described above. Check the power supply (breaker, cord, etc.).

Multilift Mobile

Vertical Platform Lift

Owner's Manual

For service or questions about this product,
please contact your installing dealer.

Dealer Name: _____

Dealer Phone: _____

Authorized Savaria Dealer

Savaria Concord Lifts, Inc.
2 Walker Drive Brampton ON L6T 5E1 Canada

 **savaria**[®]

savaria.com

Part No. 000911

©2023 Savaria Corporation