



Prolift SCL &
Prolift HD
Accessibility Lifts
Platform Lift

Planning
Guide

© savaria.

Applicable Codes:

ASME A17.1

ASME A18.1

CAN/CSA B355

CAN/CSA B613

Purpose of this guide

This planning guide is designed to assist architects, contractors and lift professionals in planning for a Prolift SCL or Prolift HD Wheelchair Lift to meet the requirements of the following codes and standards:

- ASME A18.1-2003 Section 2 (Public)
- ASME A18.1-2005 Section 2 (Public)
- ASME A18.1-2008 Section 2 (Public)
- ASME A18.1-2011 Section 2 (Public)
- ASME A18.1-2014 Section 2 (Public)
- ASME A18.1-2017 Section 2 (Public)
- ASME A18.1-2003 Section 5 (Private)
- ASME A18.1-2005 Section 5 (Private)
- ASME A18.1-2008 Section 5 (Private)
- ASME A18.1-2011 Section 5 (Private)
- ASME A18.1-2014 Section 5 (Private)
- ASME A18.1-2017 Section 5 (Private)
- ASME A17.1-1996 Section 20 (Public)
- ASME A17.1-1996 Section 21 (Private)
- CAN/CSA B355 S1-02 (Public)
- CAN/CSA-B355-09 (Public)
- CAN/CSA B613-2000 (Private)

We strongly recommend that you contact the code authority having jurisdiction in the area where the lift will be installed to become familiar with all the legal requirements governing the installation and use of lifts in commercial applications. It is extremely important for you to know and adhere to all regulations pertaining to the installation and use of lifts.

How to use this guide

- 1 Determine your client's intended use of the lift.
- 2 Determine the local code requirements.
- 3 Determine the site installation parameters.
- 4 Determine the cab type and hoistway size requirements.
- 5 Plan for machine room and electrical requirements.

IMPORTANT NOTICE

This planning guide provides nominal dimensions and specifications useful for the initial planning of a lift project. Before beginning actual construction, be sure to receive the installation (shop) drawings customized with specifications and dimensions for your specific project.

Lift configurations and dimensions are in accordance with our interpretation of the standards set forth by ASME A18.1-2008 Section 2, CAN/CSA B355 M00, B355S1-02, and B355-09. Please consult Savaria or the authorized Savaria dealer in your area for more specific information pertaining to your project, including any discrepancy between referenced standards and those of any local codes or laws. The dimensions and specifications in this planning guide are subject to change (without notice) due to product enhancements and continually evolving codes and product applications.

Revision History

- November 17, 2010 - Initial release
- December 10, 2010 - Corrected information for "Pit depth required" in table on page 5
- December 17, 2010 - Corrected information for "Pit depth required" in table on page 5; Combined sectional views on page 10; Corrected drawing on page 15; Corrected pit details on page 42
- January 10, 2011 - Added table for Prolift HD (5 HP pump unit) on page 50
- June 23, 2011 - Corrected table on page 50
- July 9, 2013 - Added Noise Level to specifications table on page 5
- March 13, 2014 - Revised Specifications table on pages 5 and 6; Revised sectional view on page 11
- November 5, 2014 - Revised Applicable Codes on page 3
- January 20, 2015 - Added new 2014 code in section above
- May 25, 2015 - Revised tables on page 51
- August 20, 2015 - Added door drawings on pages 40 to 43
- September 24, 2015 - Added Daily Cycle to specifications table on page 5
- March 8, 2016 - Removed copyright from cover page; revised Savaria Corporation back to Savaria Concord Lifts, Inc.
- July 14, 2016 - Added new Prodoor drawing on page 44
- February 9, 2016 - Added spec for distance between landings to specs table on page 4
- September 27, 2018 - Added ASME 18.1-2017 to code list above
- April 1, 2019 - Changed HD221N to HD222N in table on page 56
- May 23, 2019 - Changed max stops to 6 in specs table on page 5
- January 9, 2020 - Added note to temperature spec on page 4
- May 12, 2020 - Added new spec "floor by others (in cab)" to specs table on page 4
- May 29, 2020 - Added hoistway and pit notes on page 47
- October 30, 2020 - Revised pit depth specifications on pages 5, 6, 11, and 47
- April 8, 2021 - Moved general guide information from page 3 to page 2; updated dimensions in specifications on page 10
- May 13, 2024 - Revised specifications on page 5, revised cover page
- January 27, 2025 - Revised pages 5, 8 and 10, added revision number

Product description

Meets Americans with Disabilities Act (ADA) requirements

The Prolift SCL and Prolift HD meet the requirements of the ADA Accessibility Guidelines as a means to provide public building access.

Design assistance

With over 30 years of experience, Savaria has the expertise to provide solutions to practically every design challenge you face. Please call our Customer Service Department for professional advice at (800) 661-5112 or (905) 791-5555.

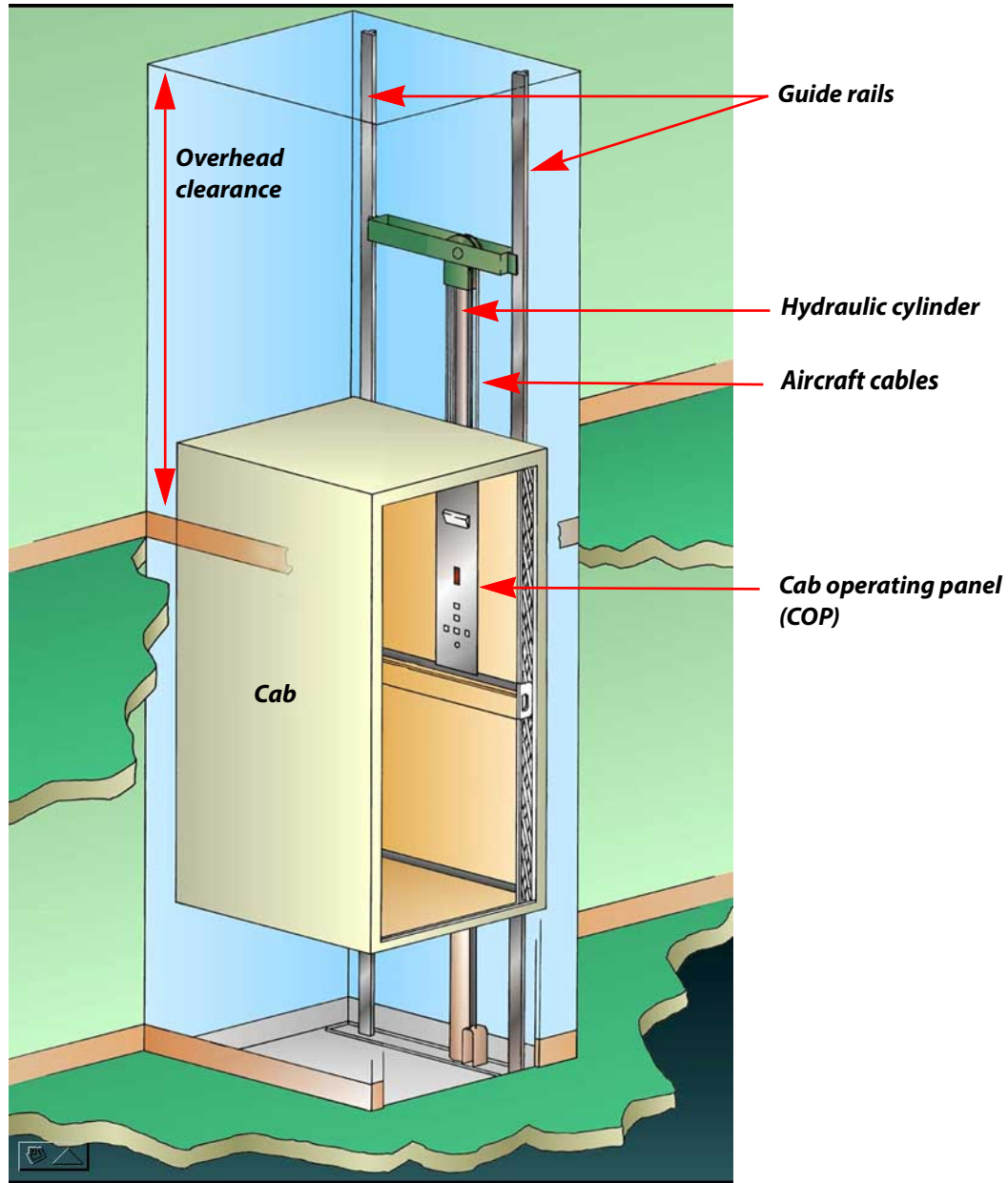

PROLIFT IN HOISTWAY

Prolift SCL and Prolift HD specifications

Specification type	Specification data
Load capacity	SCL: Standard 750 lb (341 kg), 1000 lb (454 kg); Optional 1050 lb (476 kg) HD: Standard 1050 lb (476 kg); Optional 1400 lb (635 kg) - check with local authority for code limit
Rated speed	30 ft/min (0.15 m/s) (nominal)
Power supply NOTE: Amperage may vary depending on individual units. Verify requirements prior to installation of power supply.	208 volt, three-phase, 30 amps, 60 Hz or 230 volt, single-phase, 40 amps, 60 Hz
Drive system	1:2 cable hydraulic
Daily cycle	Normal: 30 Heavy: 75 Excessive: 100 Maximum starts in 1 hour on standard installation: 15 NOTE: Please consult your Sales Representative if there a chance you may exceed these amounts.
Cab sizes	SCL Type 1L/1R, Type 2, Type 5: <ul style="list-style-type: none"> • 36" x 48" (914 mm x 1219 mm) • 36" x 54" (914 mm x 1372 mm) • 36" x 60" (914 mm x 1524 mm) • 42" x 48" (1067 mm x 1219 mm) SCL Type 3/4, Type 3/4 with 42" B wall opening: <ul style="list-style-type: none"> • 42" x 48" (1067 mm x 1219 mm) HD all cab types (Type 1L/1R, Type 2, Type 3/4, Type 3/4 with 42" B wall opening, Type 5): <ul style="list-style-type: none"> • 42" x 54" (1067 mm x 1372 mm) • 42" x 60" (1067 mm x 1524 mm) • 48" x 60" (1219 mm x 1524 mm) Optional: <ul style="list-style-type: none"> • W36" x L60" x H80" (914 mm x 1524 mm x 2032 mm) • W35" x L84" x H80" (889 mm x 2134 mm x 2032 mm), Type 1 or 2, white steel cab
Floor by others (in cab)	5/8" (15.9 mm) maximum
Maximum travel	CDN: 23 ft (7 m) – confirm with local code US: 14 ft (4.3 m) – confirm with local code
Maximum # of stops	4 stops
Pit depth required	Without Buffer Spring: 8" (203.2 mm) minimum With Buffer Spring: 11" (279.4 mm) minimum
Minimum overhead clearance	92" (2337 mm)
Control system	Constant pressure
Distance between 2 landings	18" (457 mm) minimum
Temperature operating range (environment)	18°C to 25°C (64.4°F to 77°F) NOTE: For optimal running conditions, each landing of the unit should be in a climate-controlled environment.
Noise level (for typical installation)	75.1 dBA; measured at a height of 1m, distance of 1m, in front of tank, in closed machine room
Floor selection	Magnetic selector
Flooring material	Plywood
Control panel finish	Stainless steel
Hall station finish	Stainless steel

Prolift SCL and Prolift HD specifications

Specification type	Specification data
Motor	SCL: 3 HP (2.24 kW) HD: 5 HP (3.73 kW)
Cab panel finish	Standard solid melamine panels
Lighting supply	115 volt, 60 Hz, 15 amps
Standard features	<ul style="list-style-type: none"> Anti-creep device Automatic cab on/off lighting Car top stop switch Clear anodized aluminum cab trim Data plates, capacity tags and rope tags Emergency stop and alarm buttons Emergency battery back-up for lighting, alarm and emergency lowering Upper and lower terminal limits Magnetic floor selection, stopping and re-leveling Manual reset slack rope safety switch Mechanical rail shoring blocks Negative pressure switch Pit switch Pump run timer Rail sections (8 ft optional or 16 ft standard) Recessed incandescent down lights Stainless steel handrail Two 12 V, 4 AH, sealed no maintenance batteries with 24 V, 4 amp Smart Charge™ battery charge Unfinished plywood sub-floor Variable speed pressure compensated valve with manual lowering White egg crate ceiling
Options	<ul style="list-style-type: none"> Cab floor rubber mat Emergency hands-free telephone Hose with flow control valve (15 ft, 20 ft or 25 ft) In car digital floor indicator Interlocks for doors by others Keyed on/off control panel and hall stations Lamp style hall position indicators Light screens Pipe rupture valve Pro manual or pro auto fire rated door with Prolocks Spring buffers (11" pit depth minimum) Optional cab finishes: choice of melamine or plastic laminate

Prolift cab types

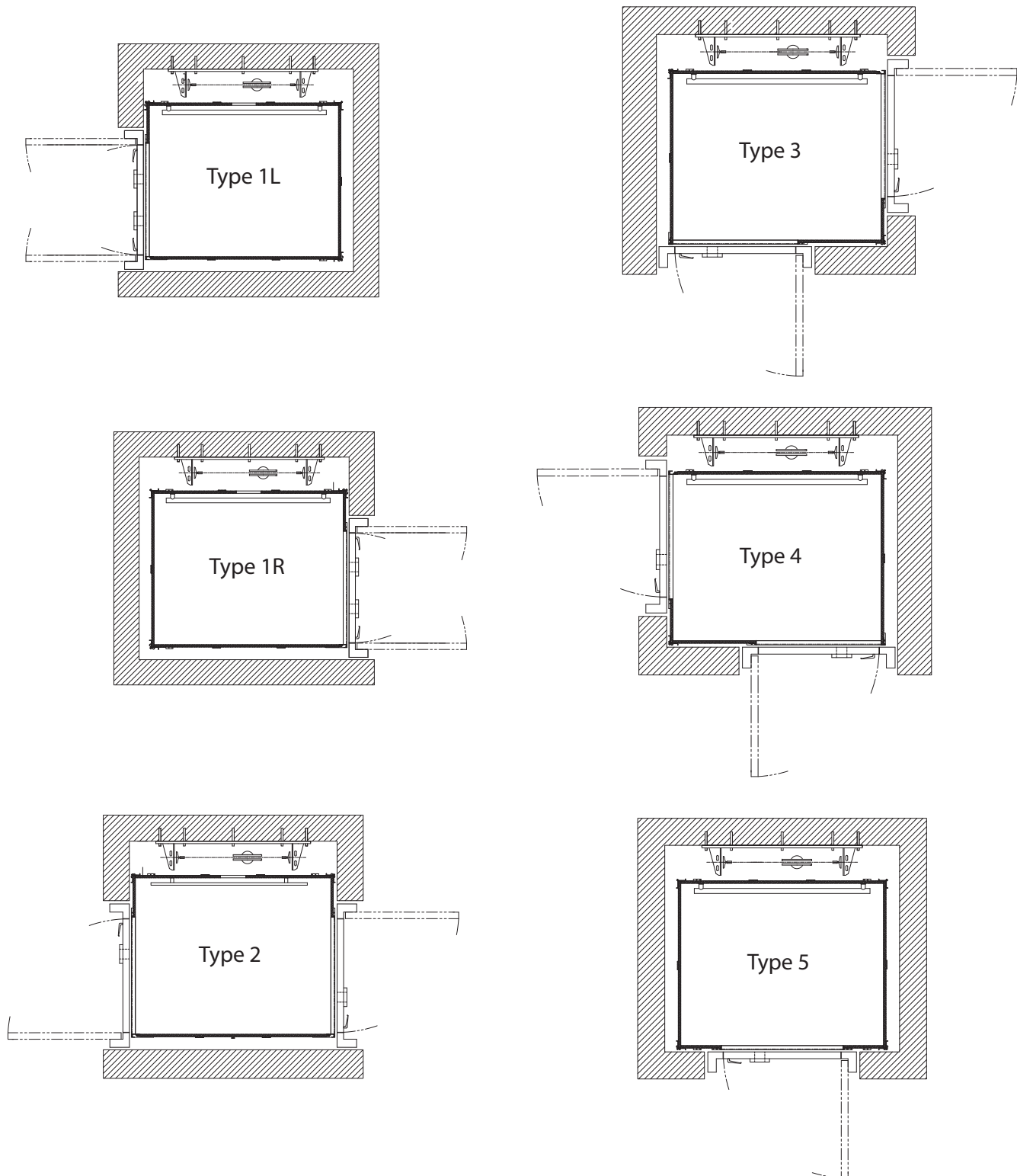

IMPORTANT

Finished hoistway dimensions must include the drywall. Determine the fire rating of the hoistway, the type and layers of sheet rock and build only off the final installation (shop) drawings specific to your project.

Machine room options

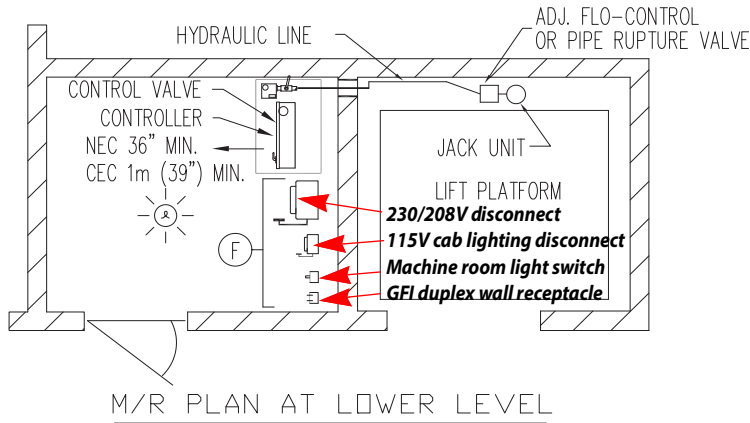

Left-hand position

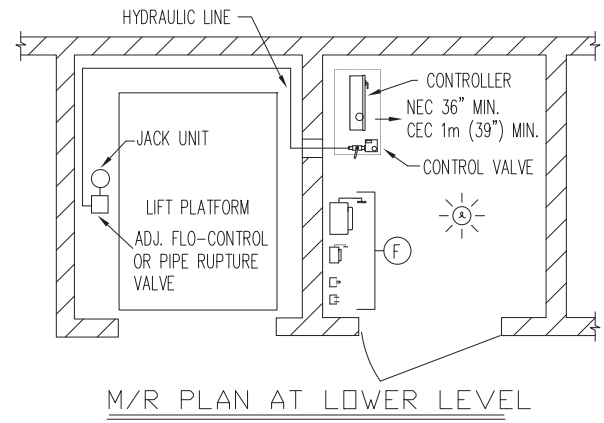

Right-hand position

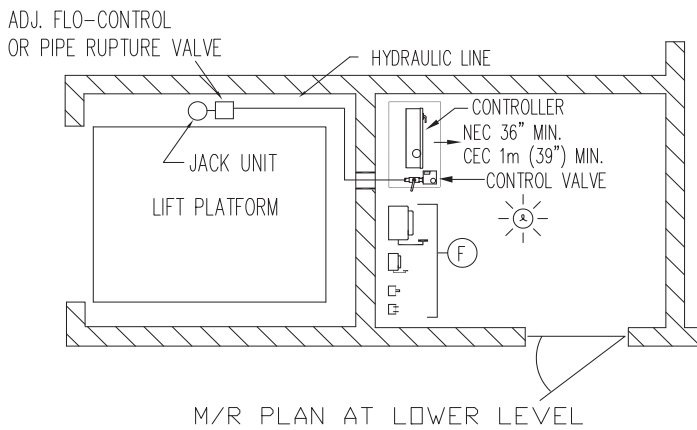

Back position

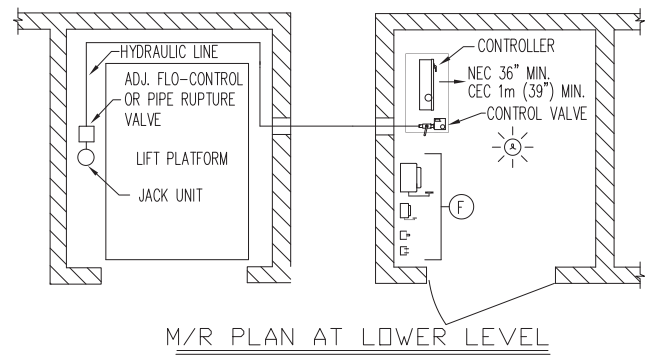

Remote position

- The machine room must be built in accordance with local, state/provincial and national codes. Adequate ventilation is required to maintain a temperature of 18°C to 25°C (64.4°F to 77°F) for output of 3600 BTU per hour.
- Power supply must be 208V three-phase with 30 amp or 230V single-phase with 40 amp dedicated circuit with equipment ground. A lockable fused disconnect with an auxiliary normally open interlock switch must be located next to the controller. The electrical circuit must terminate on the line side terminal lugs of the disconnect. It is provided and installed by others.
- The machine room lighting shall be a minimum of 19 foot candles (204 lux) at working surfaces.
- The switch for the light must be within 18" of the strike side of the machine room door.
- The switch, light and wiring are provided and installed by others. The light must be guarded to prevent accidental breakage of contact with the hot bulb. The switch, light, wiring and guard are provided and installed by others.
- A convenience outlet of 115V single-phase 15 amp with G.F.I. shall be located next to the light switch in the machine room (provided and installed by others).
- NEC requires a 30" wide x 36" deep work space in front of the disconnects and the lift controller.
- A telephone line circuit is to be provided and installed by others. This circuit must be connected to an outside line or a 24 hour central exchange.
- The machine room access door must be self closing, self locking with a key and spring return latch. Door and hardware are provided and installed by others. Consult local building codes for door construction.
- The machine room must be free of any pipes, wiring and obstructions not related to the operation of the lift. Provide a 4 inch conduit from the lift shaft to the remote machine room.

Machine room dimensions

IMPORTANT NOTE:
CONFIRM REQUIREMENTS WITH LOCAL CODE

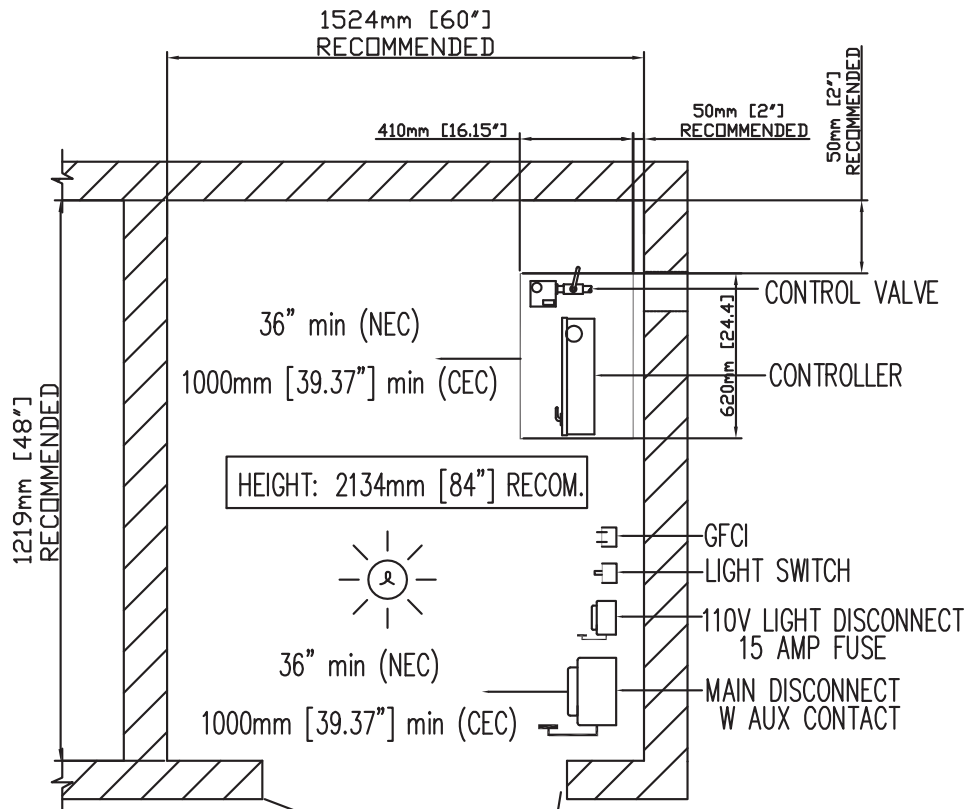

NOTE A:
POSITION OF DOORS AND COMPONENTS CAN VARY
AS LONG AS THE MINIMUM DISTANCE IN FRONT OF COMPONENTS IS RESPECTED

NOTE B:
A RACEWAY BETWEEN THE MACHINE ROOM AND HOISTWAY WILL NEED TO BE PROVIDED.
CONSULT YOUR INSTALLATION COMPANY FOR SIZE AND LOCATION

Controller tank specifications

Controller tank specifications	
Dimensions (inches)	Height: 50" (1270 mm) Width: 28" (711 mm) Depth: 17" (432 mm)
Minimum required clearance (inches)	39.37" (1000 mm)
Valve and manual lowering handle location	Inside tank
Rupture valve test	T-fitting factory installed
Tank to controller wiring	Quick connect valve and motor wiring
Controller layout	Relay board
Keyed lock to tank	Yes
Machine room required	No (with local jurisdiction approval)
Tank capacity (gal/ltr)	15-16.5 gal/57-63 ltr
Maximum dry weight (lb/kg)	147 lbs/55 kg
Maximum filled weight (lb/kg)	312 lbs/117 kg
Operating environment	18°C to 25°C(64.4°F to 77°F)
Operating volume	57 dBA

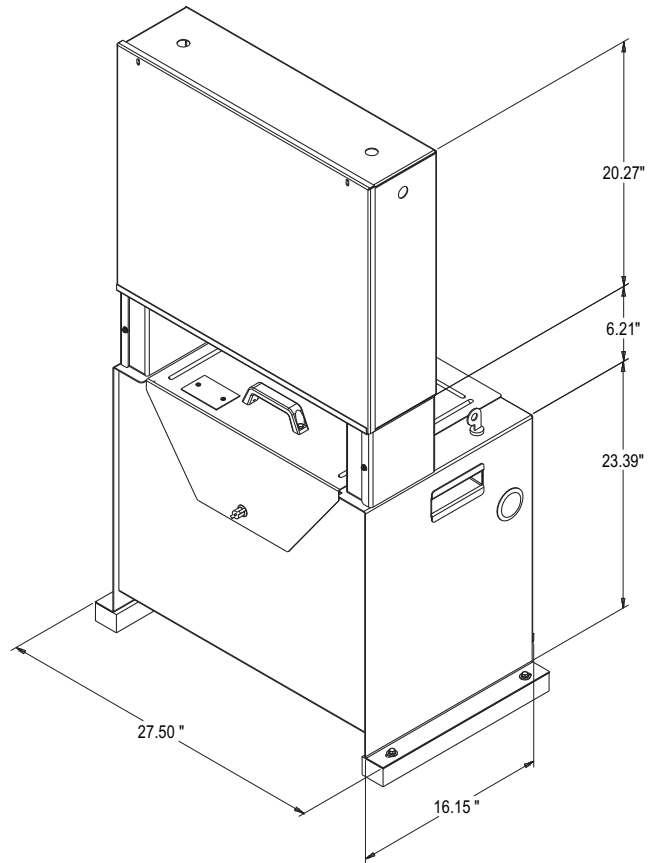

Controller tank features

- Hydraulic hose connection port on both sides of the tank
- Built-in handles on both sides of the tank
- Isolation mounting of pump motor valve assembly minimizes operating issues

Sectional view – Prolift

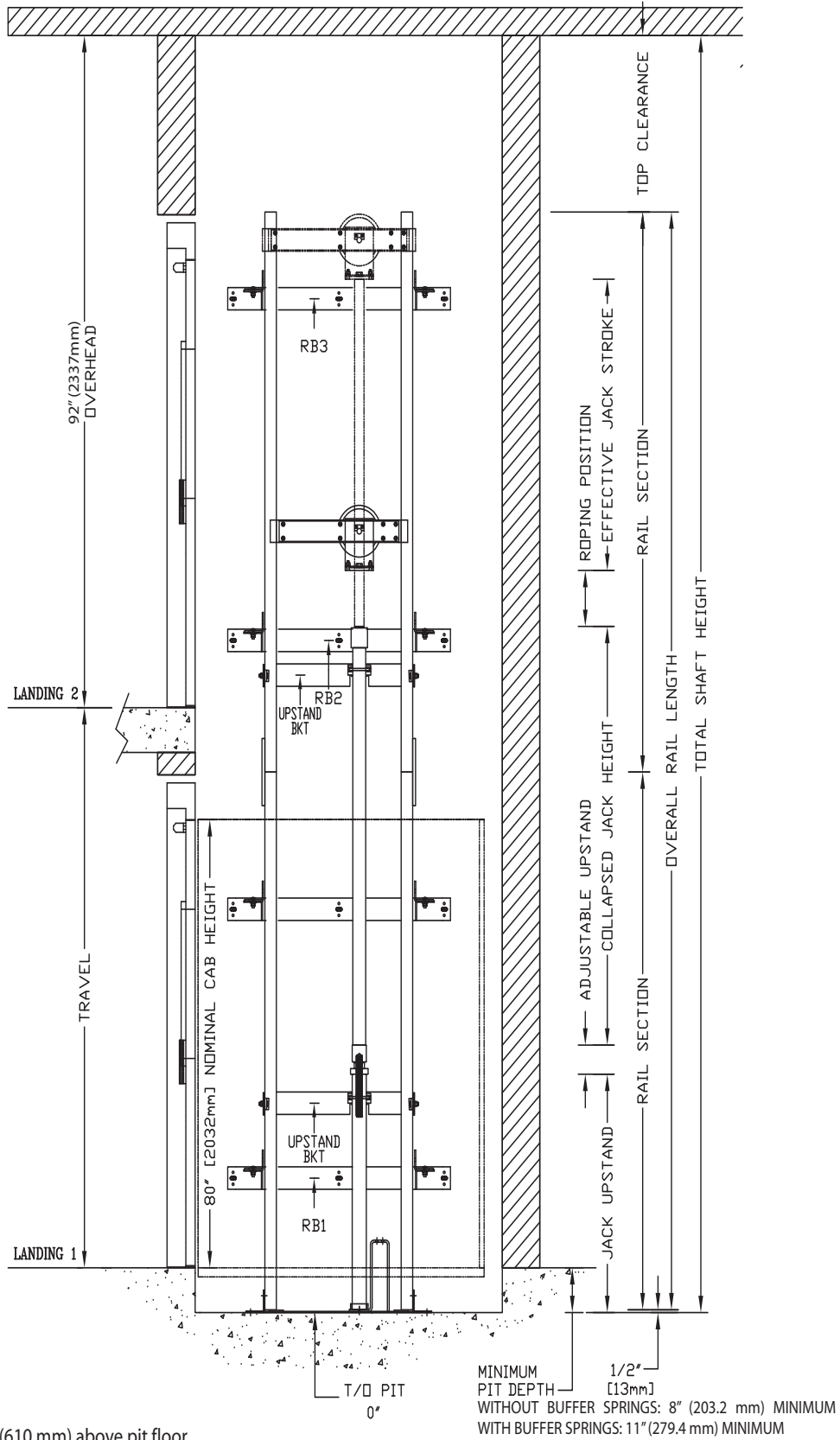

- RB1: 24 inches (610 mm) above pit floor
- RB2: 48 inches (1219 mm) intervals above bottom bracket
- RB3: at top of hoistway (contact Savaria representative for exact location)
- Minimum pit depth: 8" (203.2 mm) without buffer springs, or 11" (279.4 mm) with buffer springs
- Minimum overhead clearance: 92 inches (2337 mm)

Plan view – Prolift SCL type 1 left-hand (36" x 48", 36" x 54", 36" x 60")

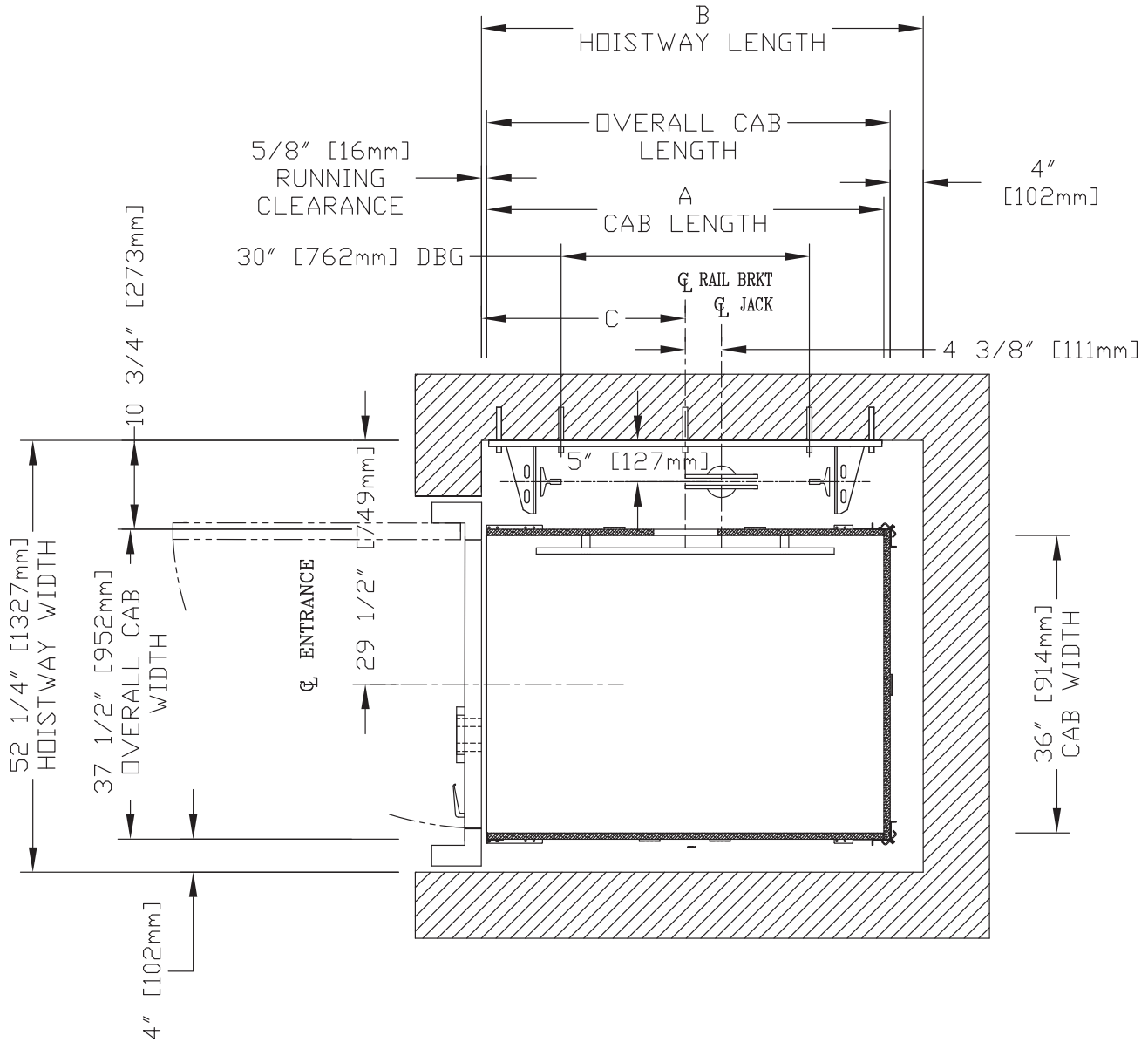

HOISTWAY DIMENSIONS

A CAB LENGTH		B HOISTWAY LENGTH		C RAIL BRKT CENTER LINE	
mm	Inches	mm	Inches	mm	Inches
1219	48	1356	53 3/8	635	25
1372	54	1508	59 3/8	711	28
1524	60	1661	65 3/8	787	31

Plan view – Prolift SCL type 1 left-hand (42" x 48")

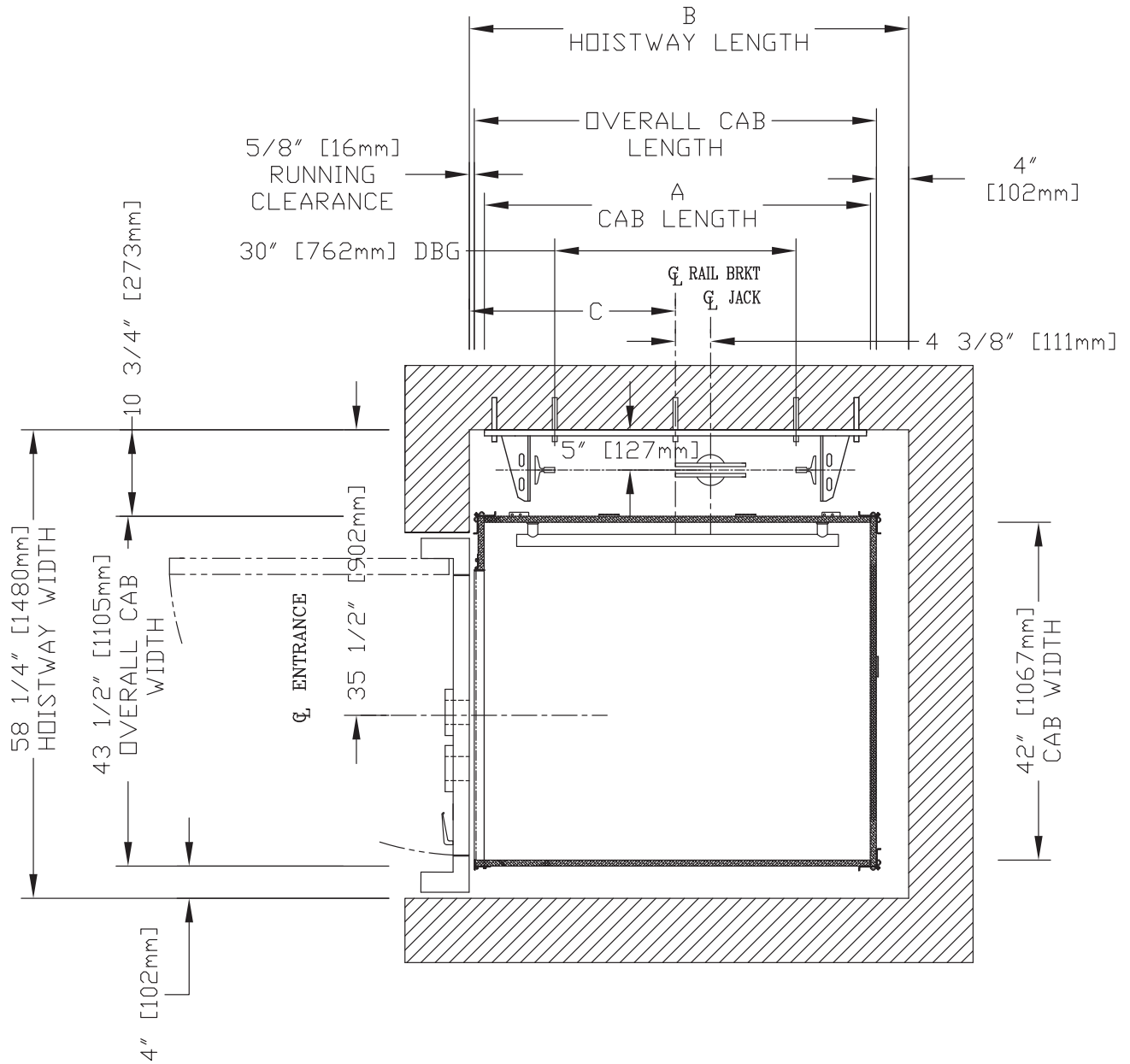

HOISTWAY DIMENSIONS

A CAB LENGTH		B HOISTWAY LENGTH		C RAIL BRKT CENTER LINE	
mm	Inches	mm	Inches	mm	Inches
1219	48	1387	54 5/8	651	25 5/8

Plan view – Prolift SCL type 1 right-hand (36" x 48", 36" x 54", 36" x 60")

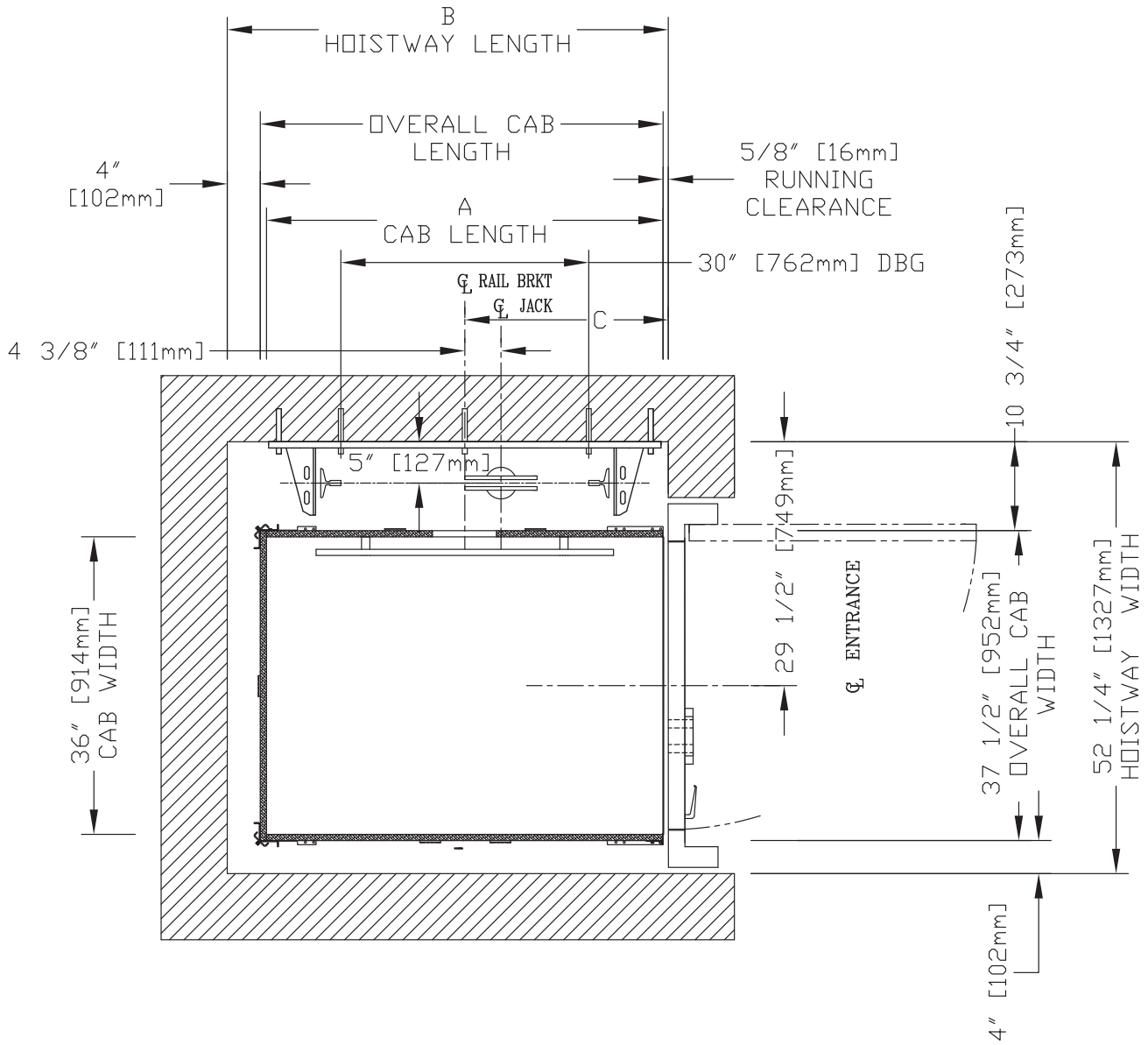

HOISTWAY DIMENSIONS

A CAB LENGTH		B HOISTWAY LENGTH		C RAIL BRKT CENTER LINE	
mm	Inches	mm	Inches	mm	Inches
1219	48	1356	53 3/8	635	25
1372	54	1508	59 3/8	711	28
1524	60	1661	65 3/8	787	31

Plan view – Prolift SCL type 1 right-hand (42" x 48")

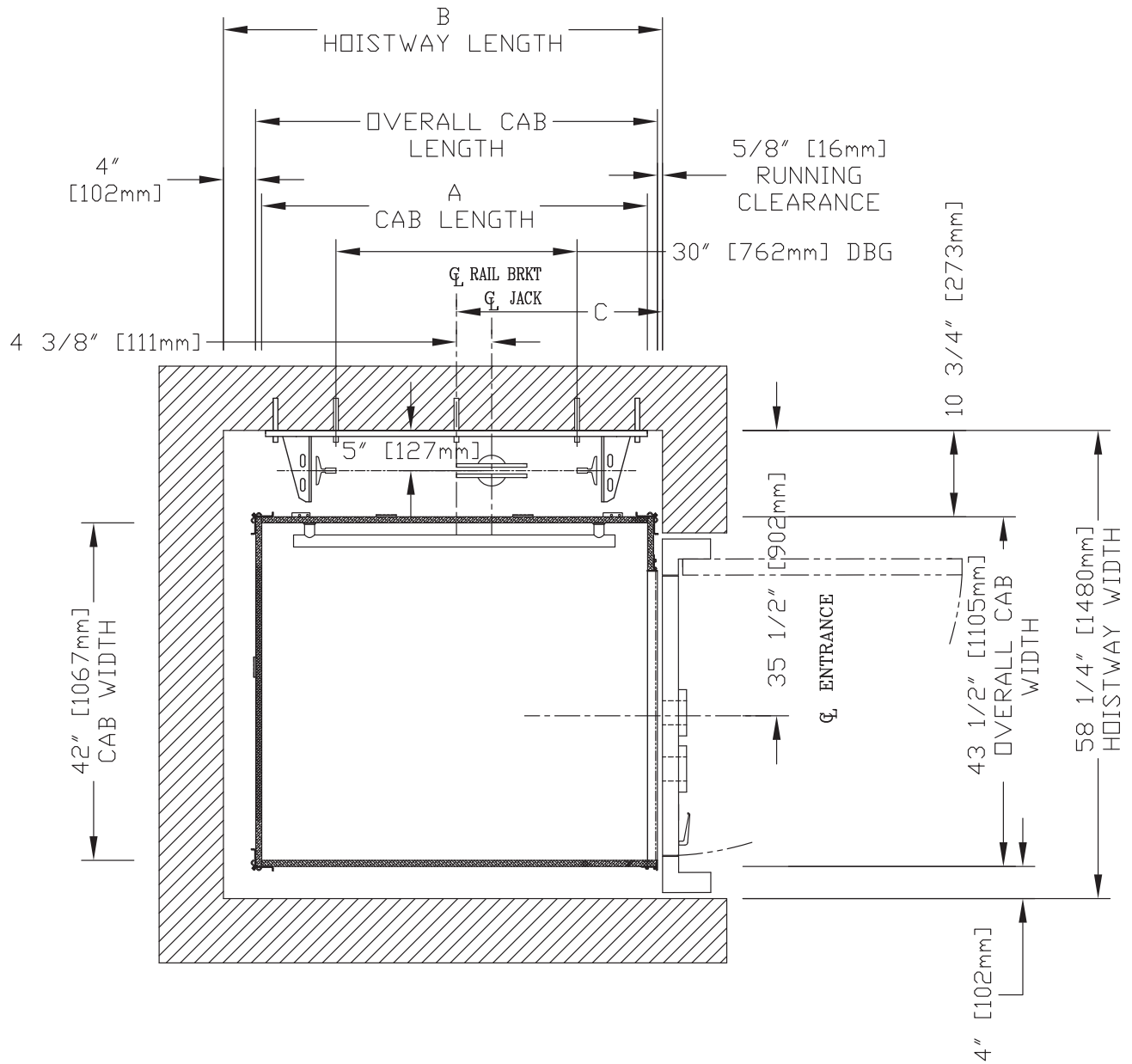

HOISTWAY DIMENSIONS

A CAB LENGTH		B HOISTWAY LENGTH		C RAIL BRKT CENTER LINE	
mm	Inches	mm	Inches	mm	Inches
1219	48	1387	54 5/8	651	25 5/8

Plan view – Prolift SCL type 2 (36" x 48", 36" x 54", 36" x 60")

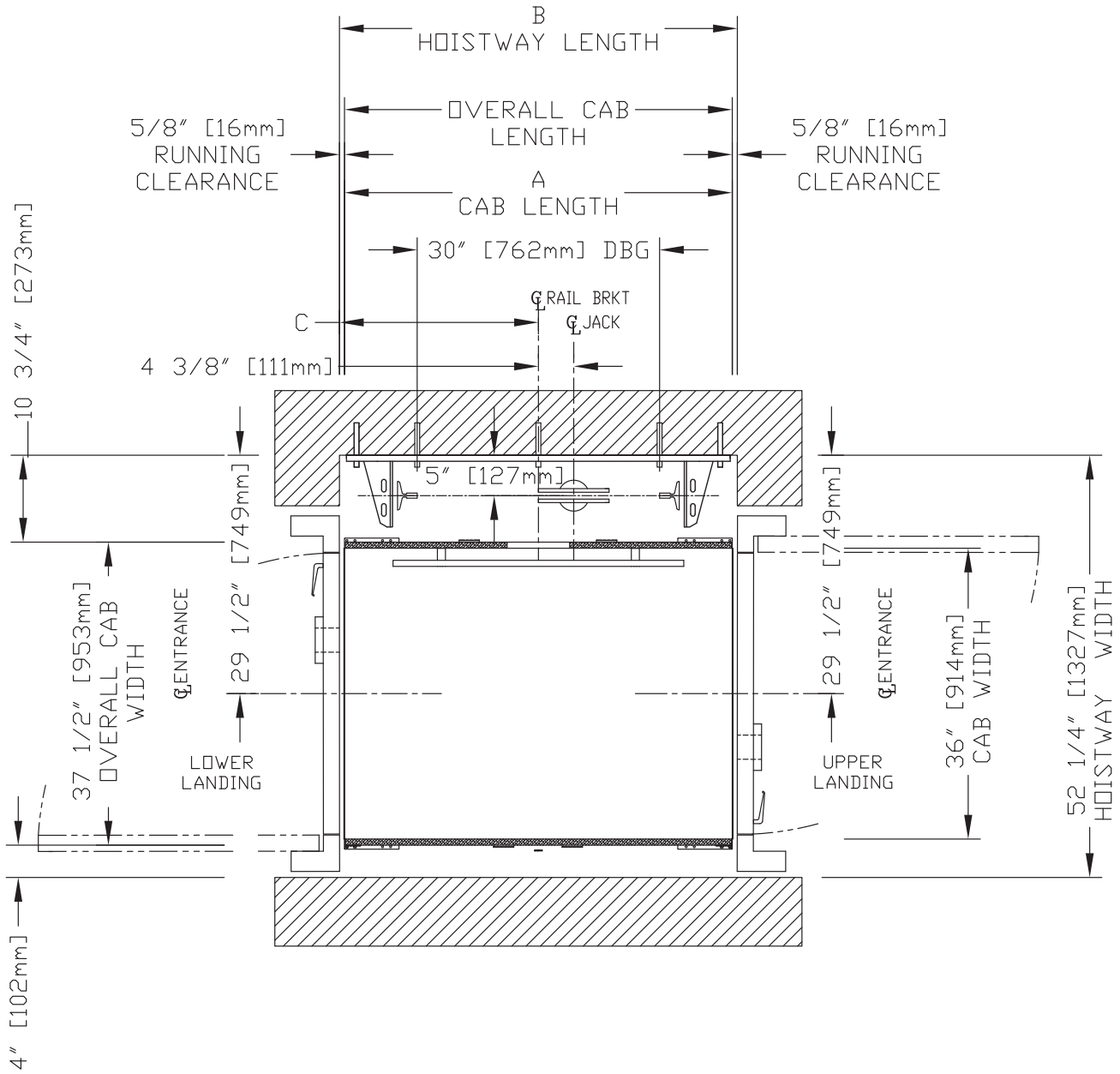

HOISTWAY DIMENSIONS

A CAB LENGTH		B HOISTWAY LENGTH		C RAIL BRKT CENTER LINE	
mm	Inches	mm	Inches	mm	Inches
1219	48	1251	49 1/4	625	24 5/8
1372	54	1403	55 1/4	702	27 5/8
1524	60	1556	61 1/4	778	30 5/8

Plan view – Prolift SCL type 2 (42" x 48")

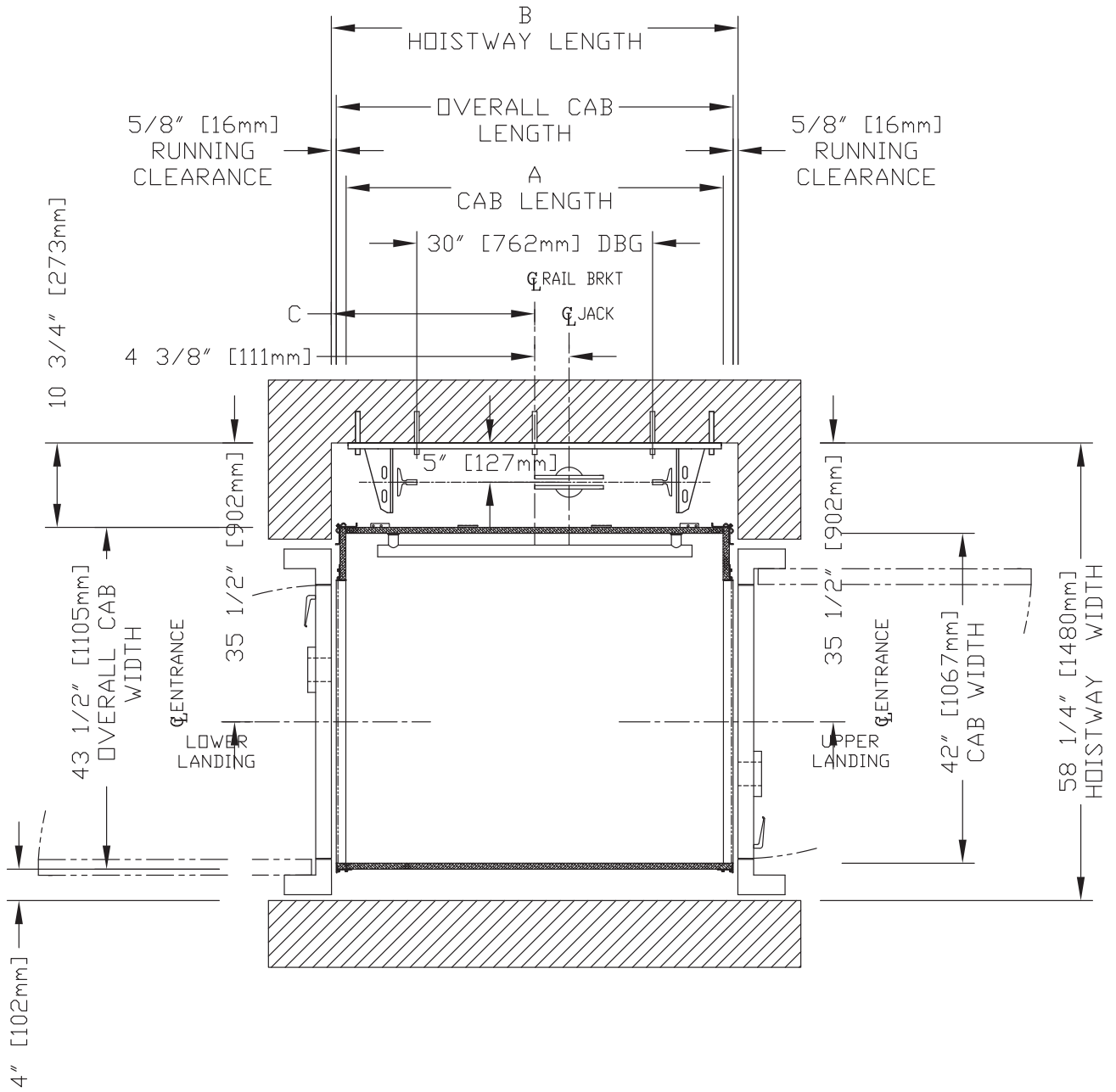

HOISTWAY DIMENSIONS

A CAB LENGTH		B HOISTWAY LENGTH		C RAIL BRKT CENTER LINE	
mm	Inches	mm	Inches	mm	Inches
1219	48	1314	51 3/4	657	25 7/8

Plan view – Prolift SCL type 3 (42" x 48")

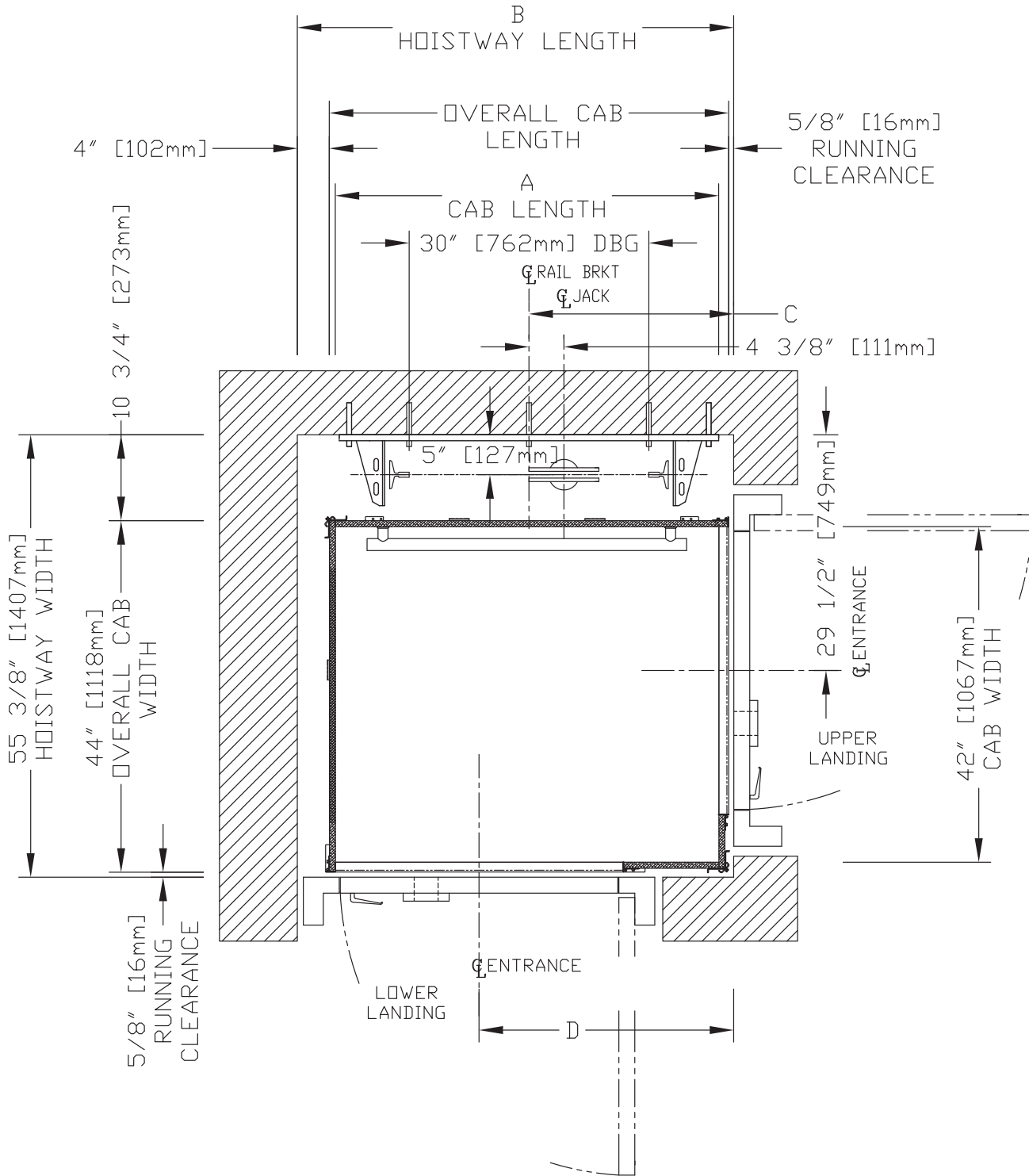

HOISTWAY DIMENSIONS

A CAB LENGTH		B HOISTWAY LENGTH		C RAIL BRKT CENTER LINE		D ENTRANCE CENTER LINE	
mm	Inches	mm	Inches	mm	Inches	mm	Inches
1219	48	1387	54 5/8	651	25 5/8	810	31 7/8

Plan view – Prolift SCL type 3 – 42" B wall opening (42" x 48")

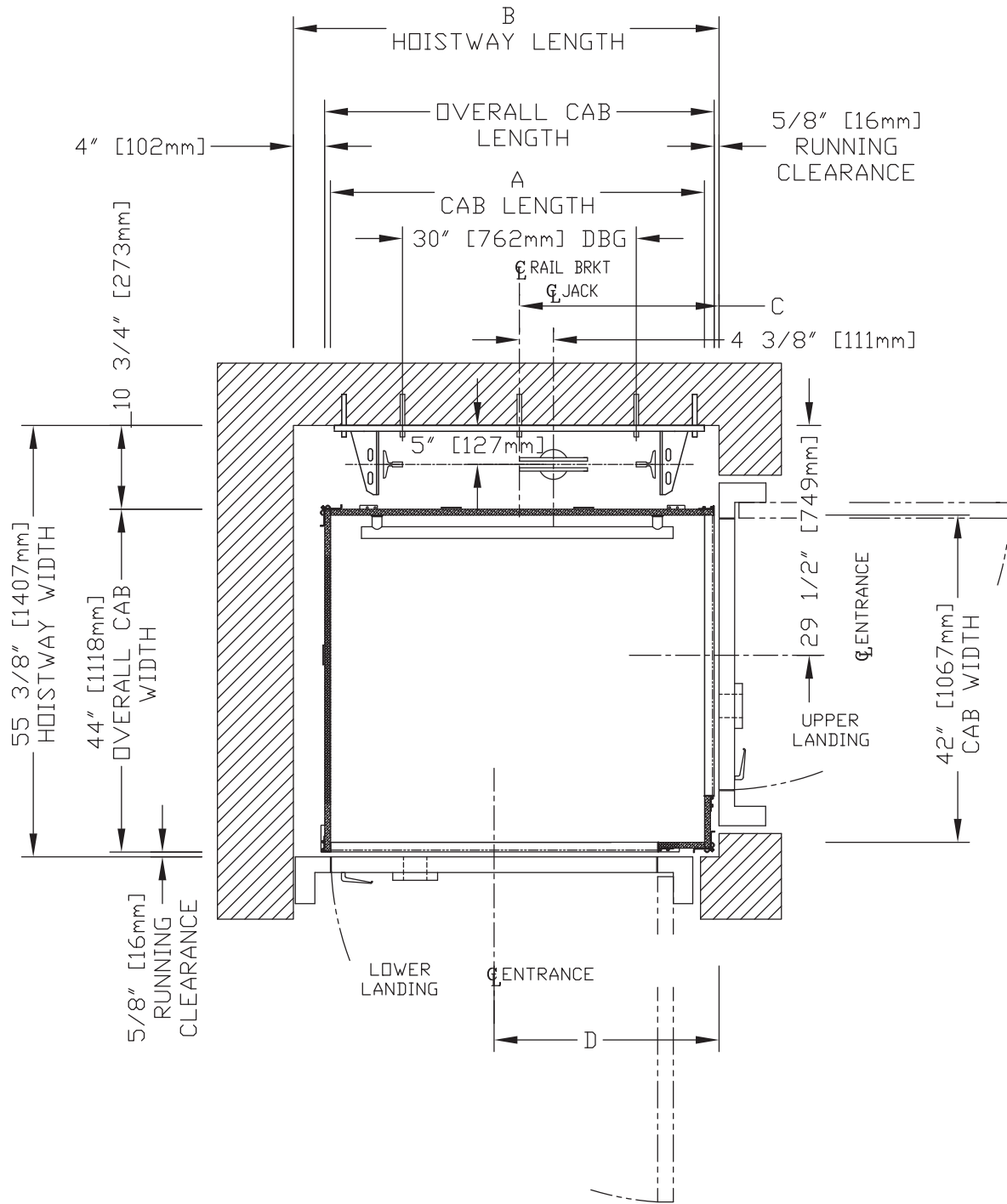

HOISTWAY DIMENSIONS

A CAB LENGTH		B HOISTWAY LENGTH		C RAIL BRKT CENTER LINE		D ENTRANCE CENTER LINE	
mm	Inches	mm	Inches	mm	Inches	mm	Inches
1219	48	1387	54 5/8	651	25 5/8	733	28 7/8

Plan view – Prolift SCL type 4 (42" x 48")

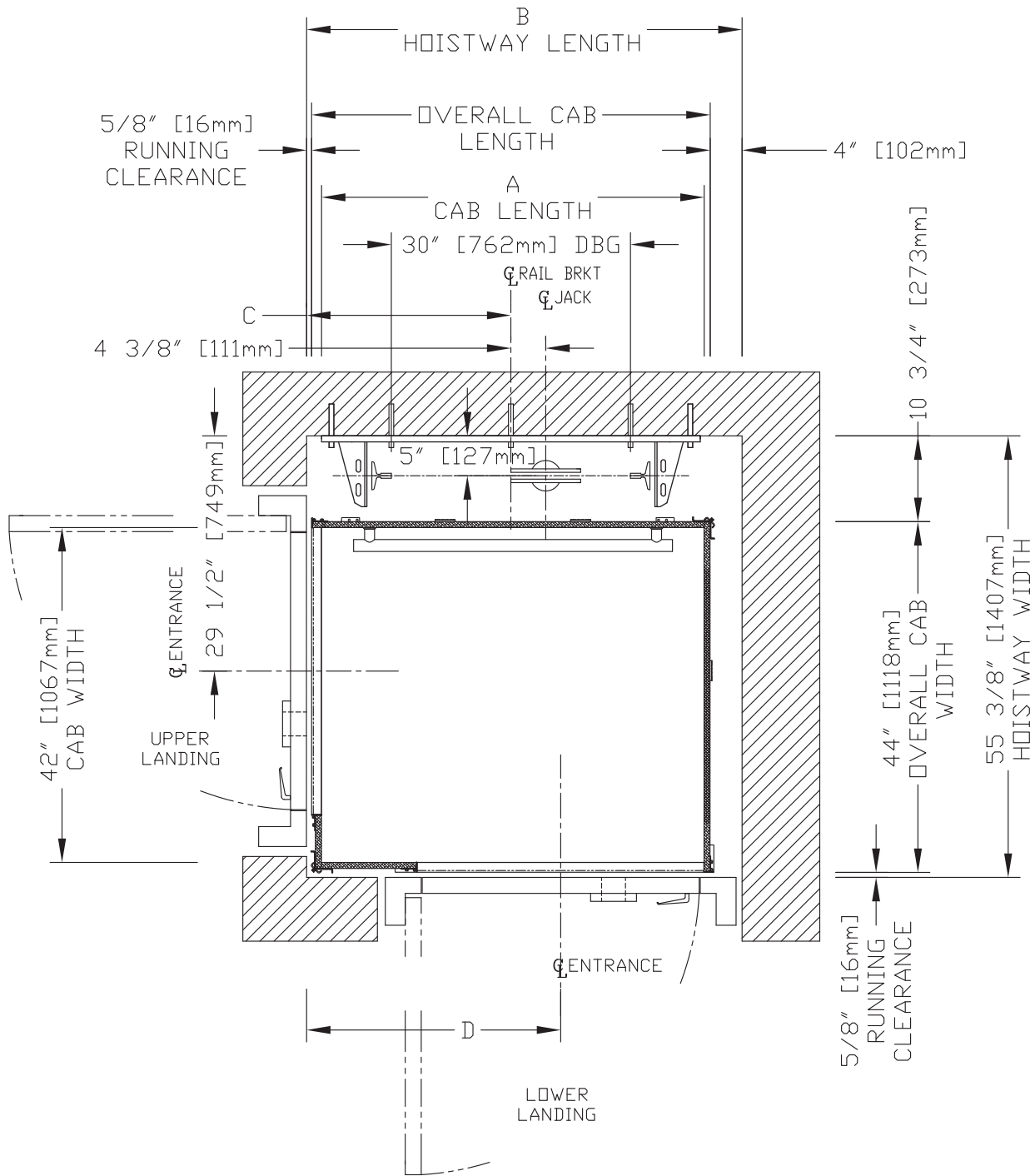

HOISTWAY DIMENSIONS

A CAB LENGTH		B HOISTWAY LENGTH		C RAIL BRKT CENTER LINE		D ENTRANCE CENTER LINE	
mm	Inches	mm	Inches	mm	Inches	mm	Inches
1219	48	1387	54 5/8	651	25 5/8	810	31 7/8

Plan view – Prolift SCL type 4 – 42" B wall opening (42" x 48")

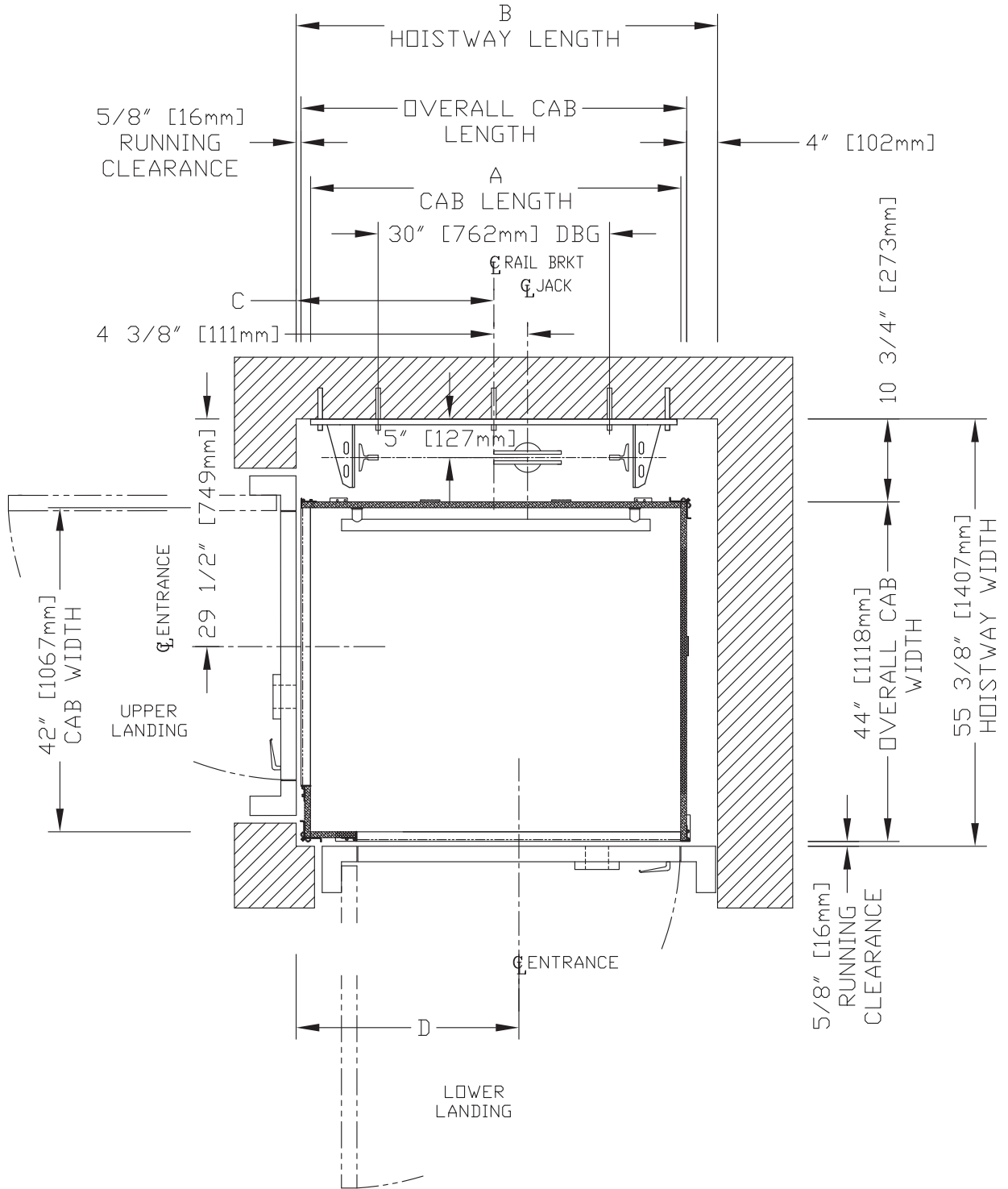

HOISTWAY DIMENSIONS

A CAB LENGTH		B HOISTWAY LENGTH		C RAIL BRKT CENTER LINE		D ENTRANCE CENTER LINE	
mm	Inches	mm	Inches	mm	Inches	mm	Inches
1219	48	1387	54 5/8	651	25 5/8	733	28 7/8

Plan view – Prolift SCL type 5 (36" x 48", 36" x 54", 36" x 60")

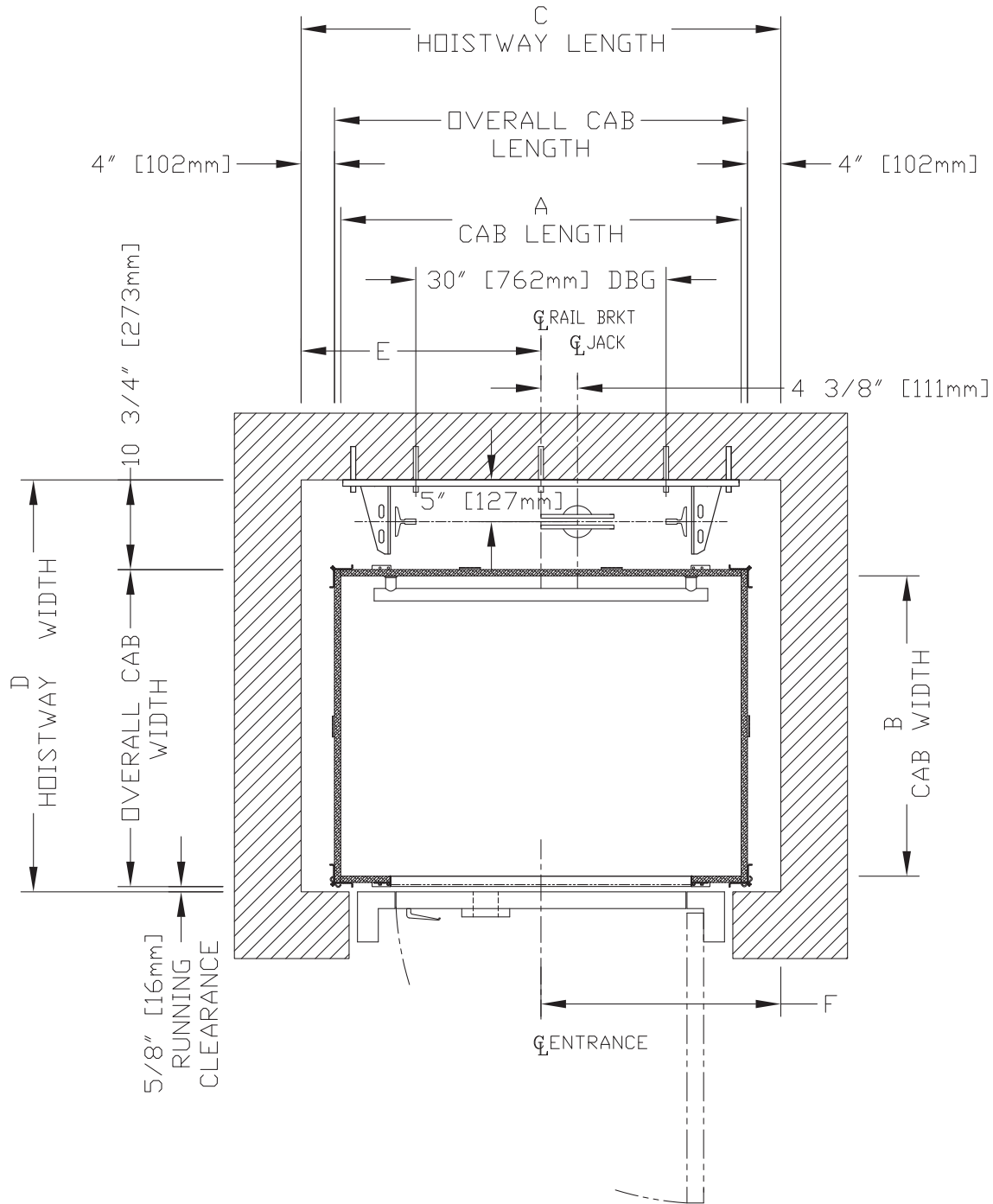

HOISTWAY DIMENSIONS

A CAB LENGTH		B CAB WIDTH		C HOISTWAY LENGTH		D HOISTWAY WIDTH		E RAIL BRKT CENTER LINE		F ENTRANCE CENTER LINE	
mm	Inches	mm	Inches	mm	Inches	mm	Inches	mm	Inches	mm	Inches
1219	48	914	36	1461	57 1/2	1254	49 3/8	730	28 3/4	730	28 3/4
1372	54	914	36	1613	63 1/2	1254	49 3/8	806	31 3/4	806	31 3/4
1524	60	914	36	1765	69 1/2	1254	49 3/8	883	34 3/4	883	34 3/4

Plan view – Prolift SCL type 5 (42" x 48")

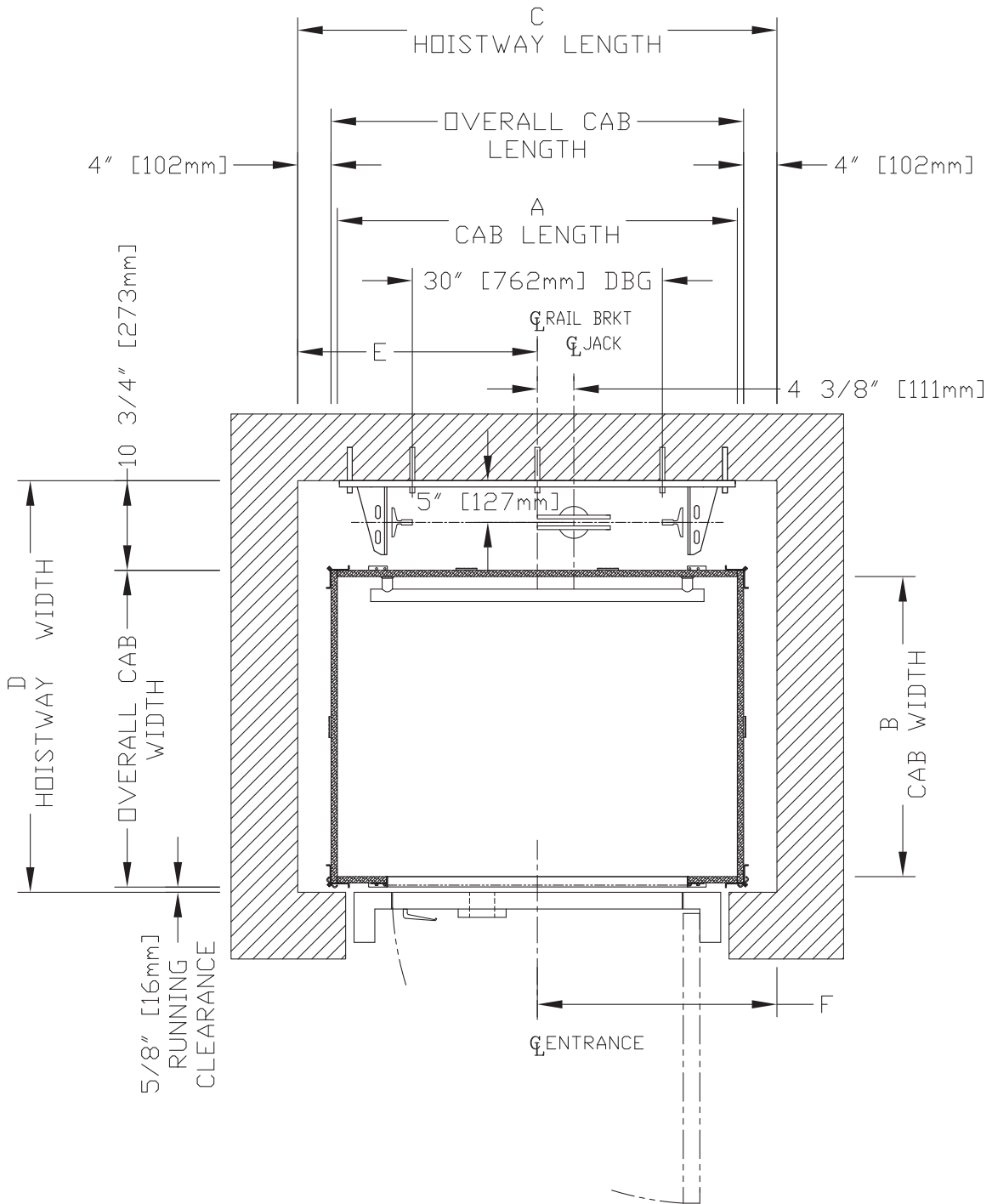

HOISTWAY DIMENSIONS

A CAB LENGTH		B CAB WIDTH		C HOISTWAY LENGTH		D HOISTWAY WIDTH		E RAIL BRKT CENTER LINE		F ENTRANCE CENTER LINE	
mm	Inches	mm	Inches	mm	Inches	mm	Inches	mm	Inches	mm	Inches
1219	48	1067	42	1461	57 1/2	1407	55 3/8	730	28 3/4	730	28 3/4

Plan view – Prolift HD type 1 left-hand (42" x 54", 42" x 60")

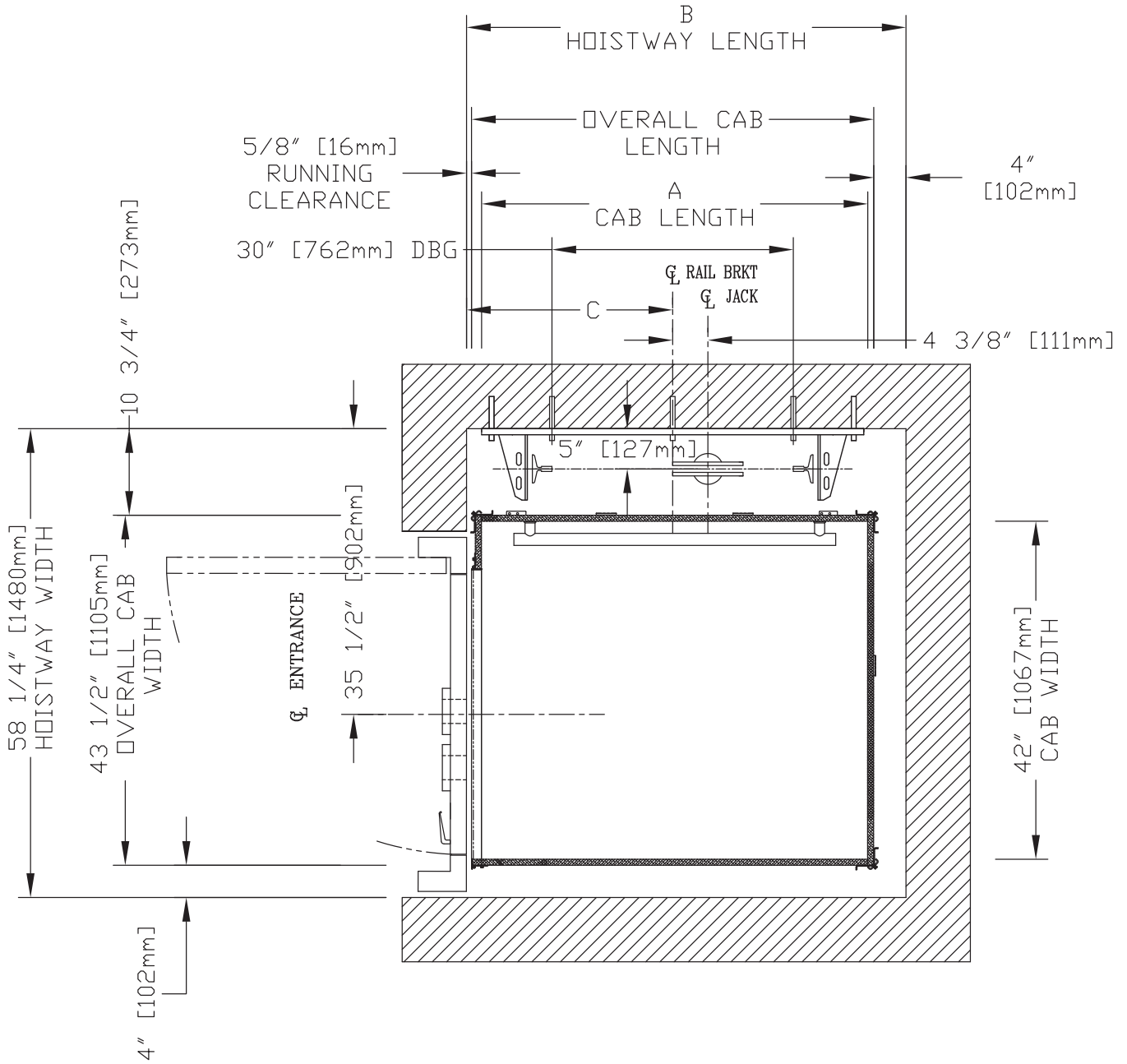

HOISTWAY DIMENSIONS

A CAB LENGTH		B HOISTWAY LENGTH		C RAIL BRKT CENTER LINE	
mm	Inches	mm	Inches	mm	Inches
1372	54	1540	60 5/8	727	28 5/8
1524	60	1692	66 5/8	803	31 5/8

Plan view – Prolift HD type 1 left-hand (48" x 60")

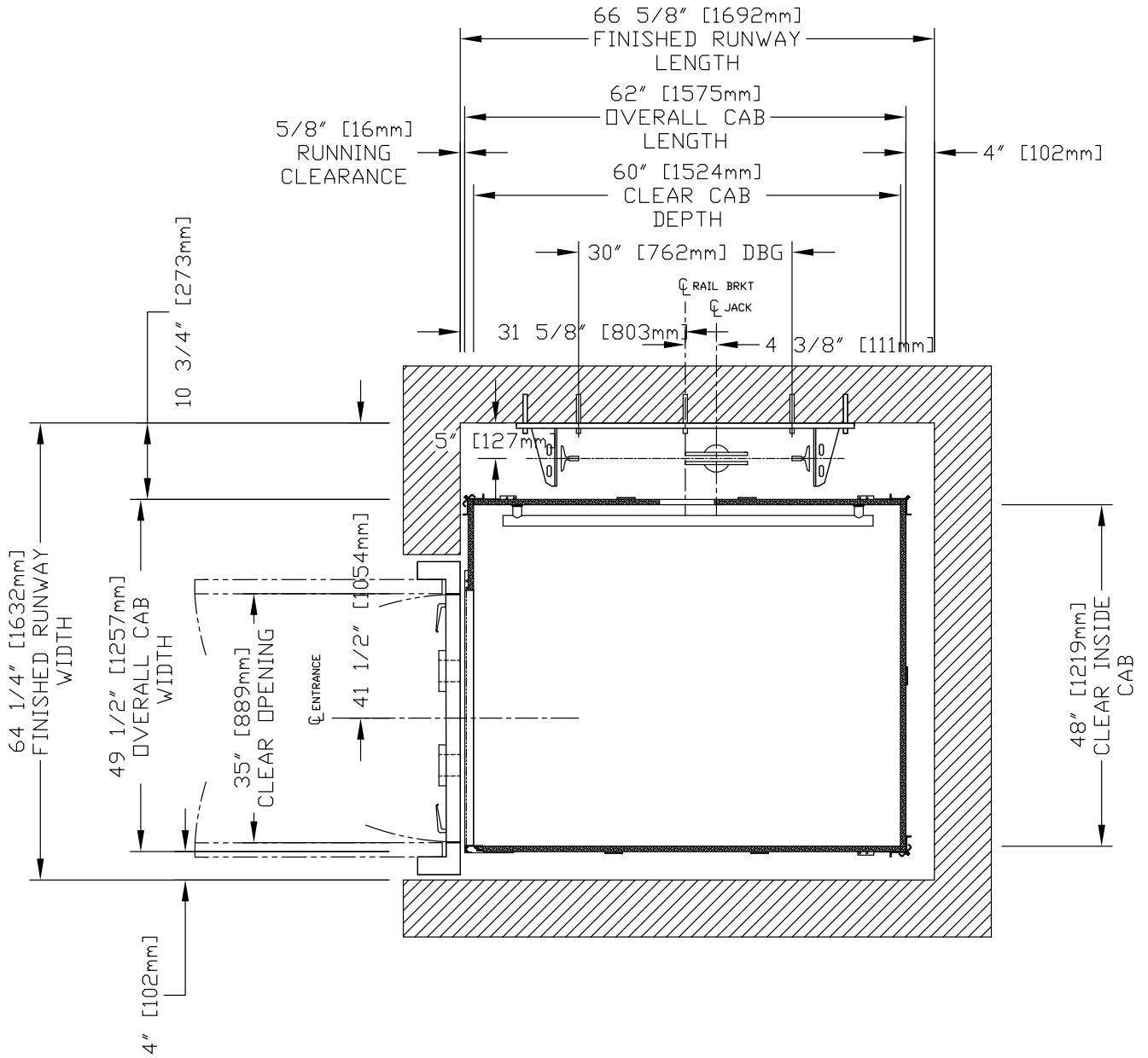

Plan view – Prolift HD type 1 right-hand (42" x 54", 42" x 60")

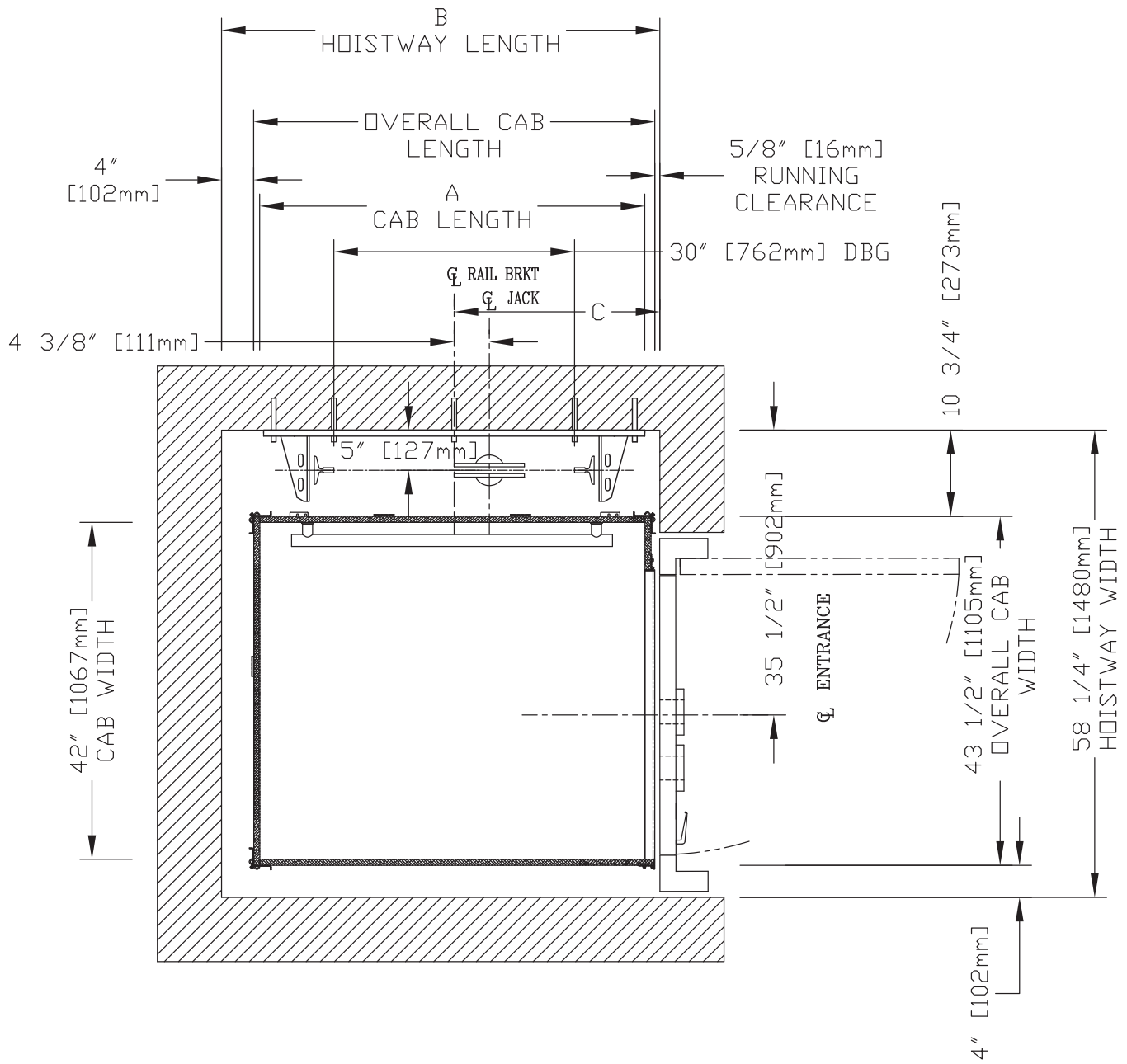

HOISTWAY DIMENSIONS

A CAB LENGTH		B HOISTWAY LENGTH		C RAIL BRKT CENTER LINE	
mm	Inches	mm	Inches	mm	Inches
1372	54	1540	60 5/8	727	28 5/8
1524	60	1692	66 5/8	803	31 5/8

Plan view – Prolift HD type 1 right-hand (48" x 60")

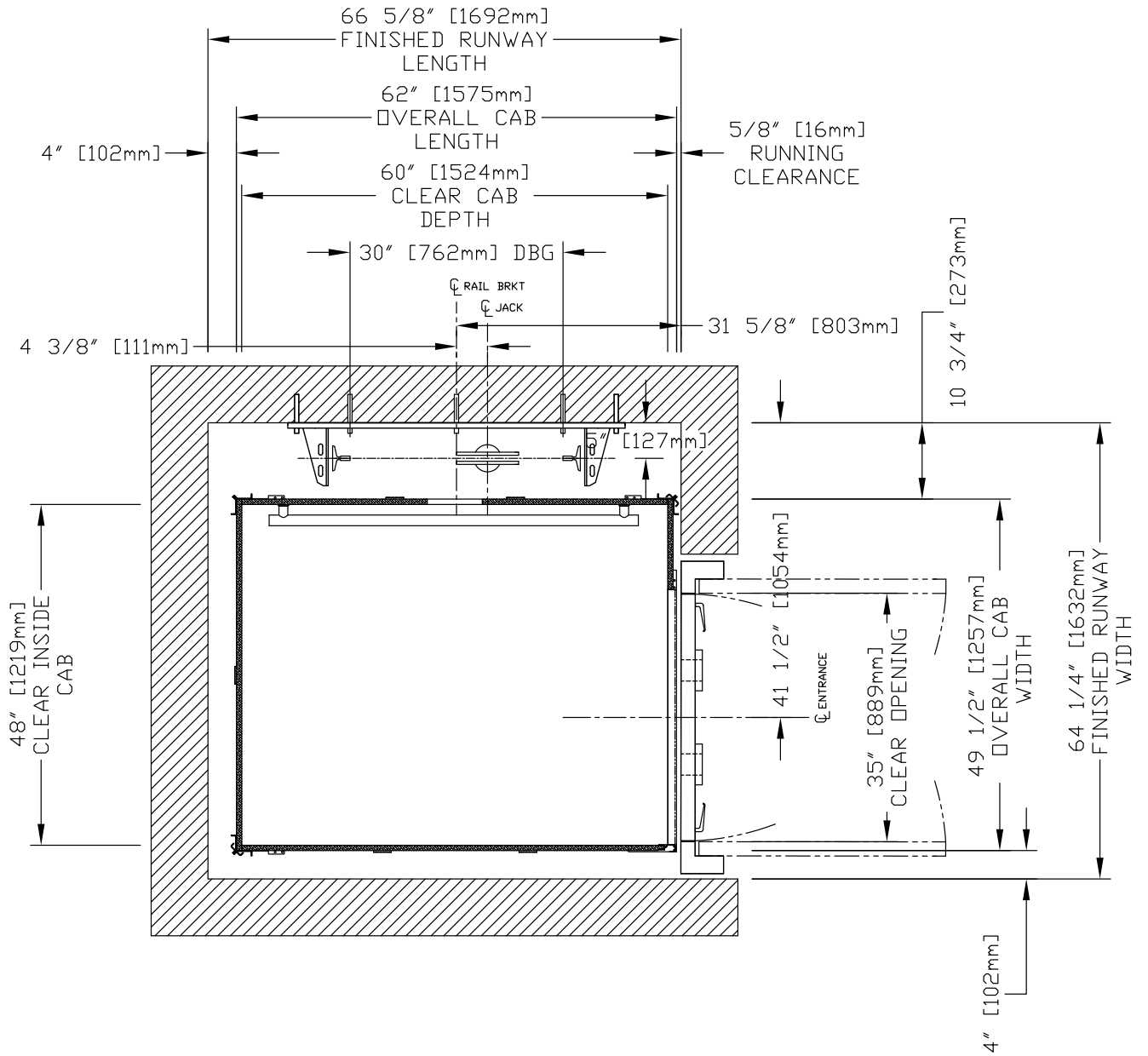

Plan view – Prolift HD type 2 (42" x 54", 42" x 60")

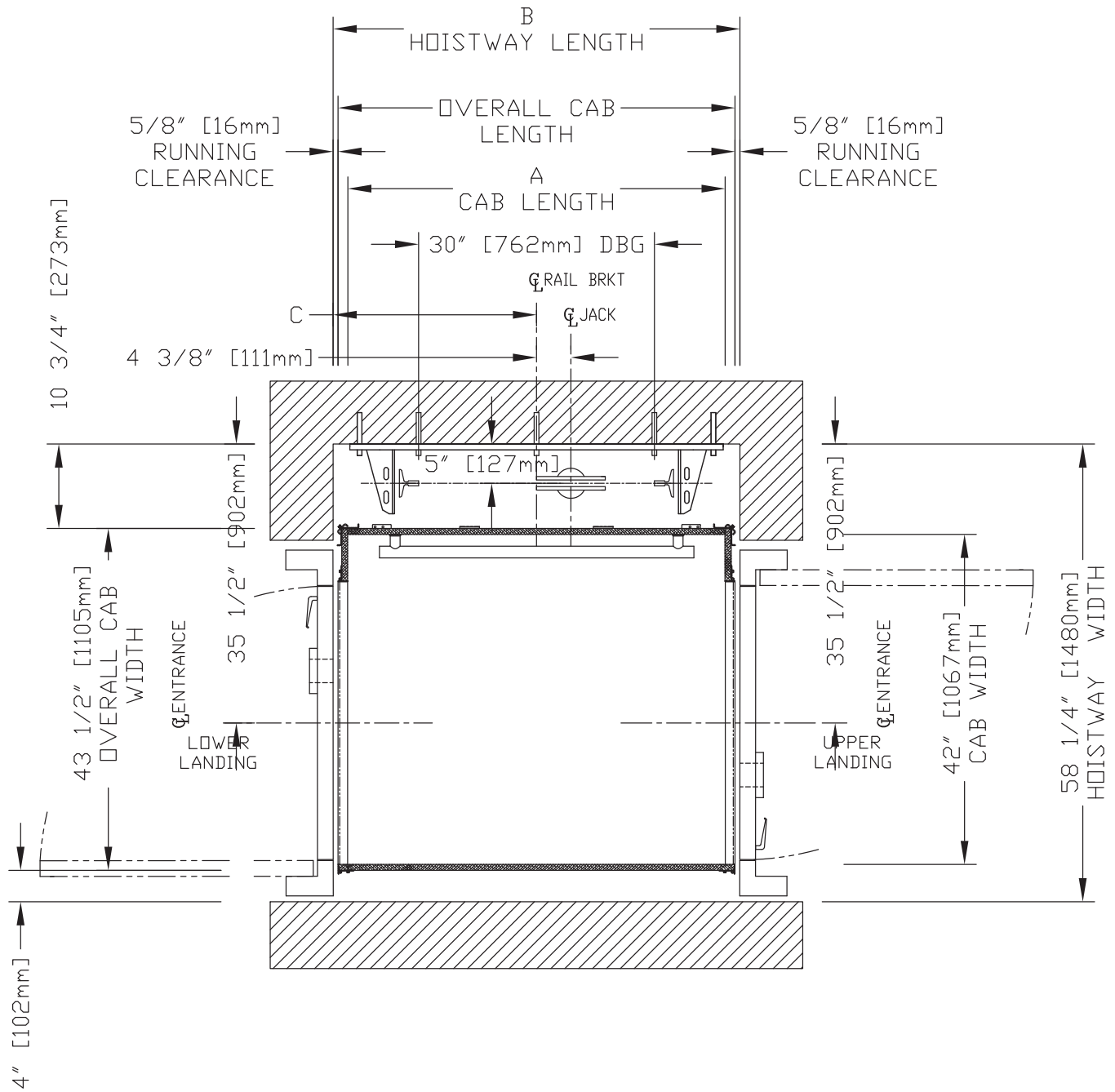

HOISTWAY DIMENSIONS

A CAB LENGTH		B HOISTWAY LENGTH		C RAIL BRKT CENTER LINE	
mm	Inches	mm	Inches	mm	Inches
1372	54	1467	57 3/4	733	28 7/8
1524	60	1619	63 3/4	810	31 7/8

Plan view – Prolift HD type 2 (48" x 60")

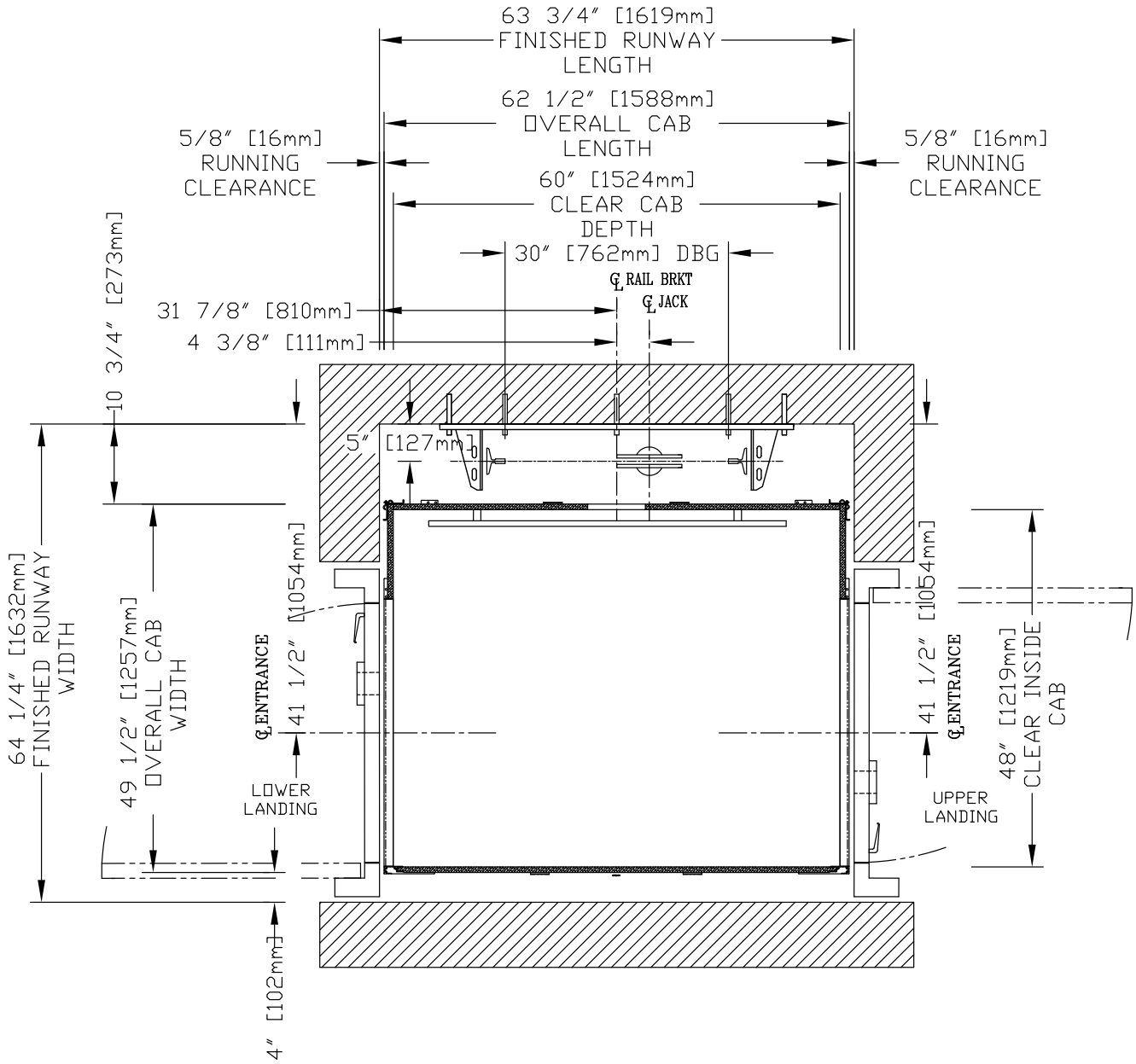

Plan view – Prolift HD type 3 (42" x 54", 42" x 60")

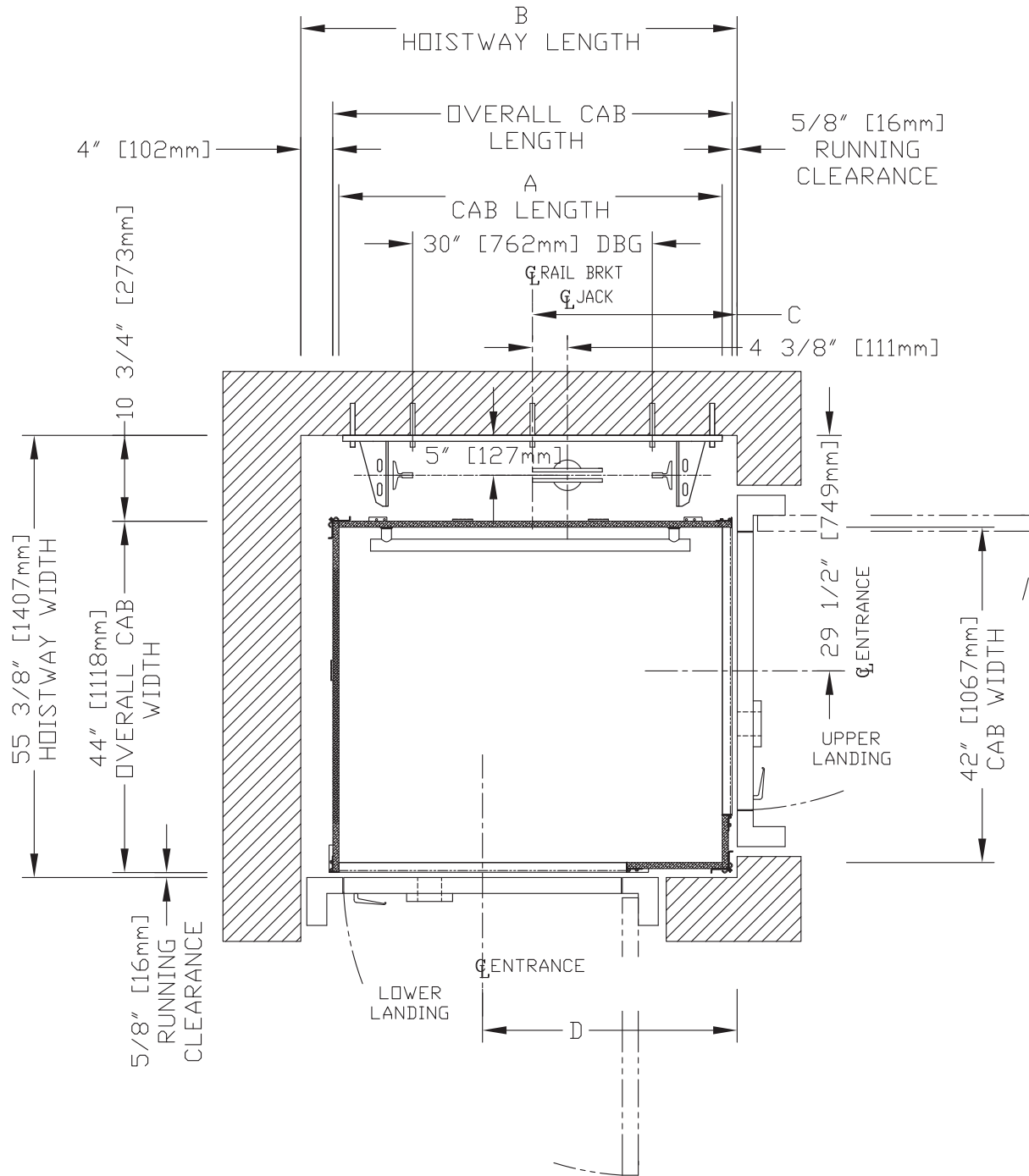

HOISTWAY DIMENSIONS

A CAB LENGTH		B HOISTWAY LENGTH		C RAIL BRKT CENTER LINE		D ENTRANCE CENTER LINE	
mm	Inches	mm	Inches	mm	Inches	mm	Inches
1372	54	1540	60 5/8	727	28 5/8	962	37 7/8
1524	60	1692	66 5/8	803	31 5/8	1114	43 7/8

Plan view - Prolift HD type 3 (48" x 60")

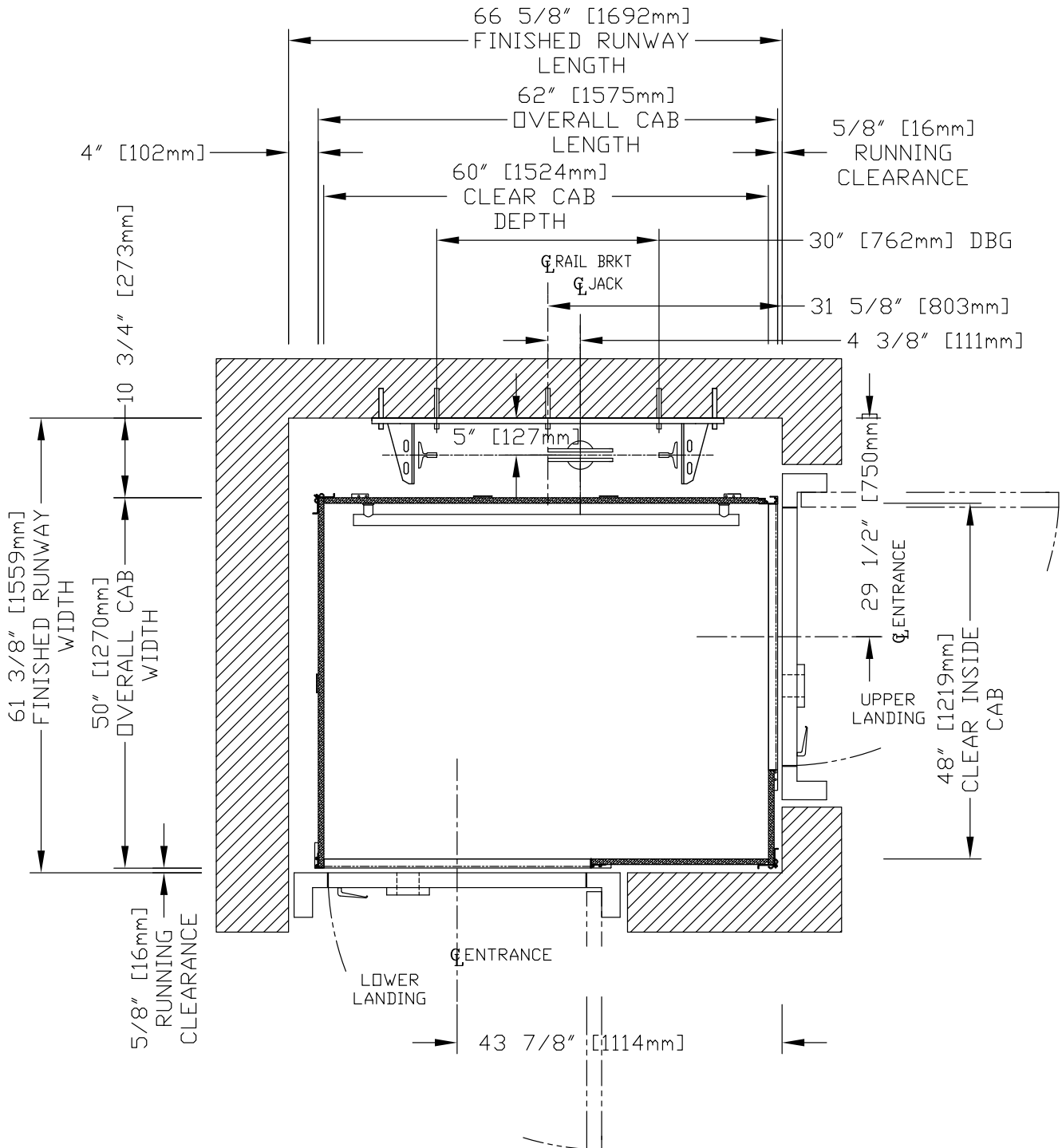

Plan view – Prolift HD type 3 – 42" B wall opening (42" x 54", 42" x 60")

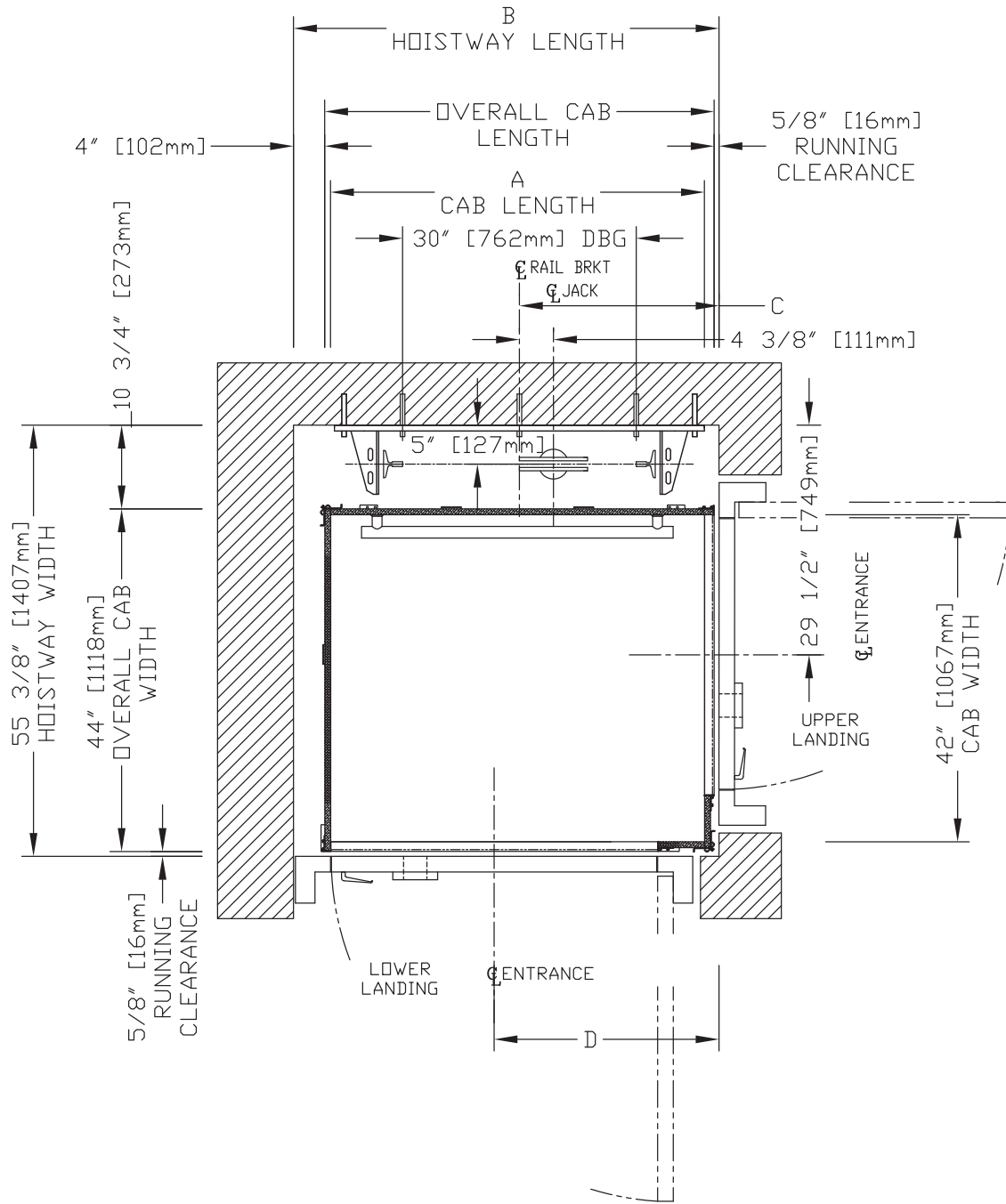

HOISTWAY DIMENSIONS

A CAB LENGTH		B HOISTWAY LENGTH		C RAIL BRKT CENTER LINE		D ENTRANCE CENTER LINE	
mm	Inches	mm	Inches	mm	Inches	mm	Inches
1372	54	1540	60 5/8	727	28 5/8	886	34 7/8
1524	60	1692	66 5/8	803	31 5/8	1038	40 7/8

Plan view - Prolift HD type 3 - 42" B wall opening (48" x 60")

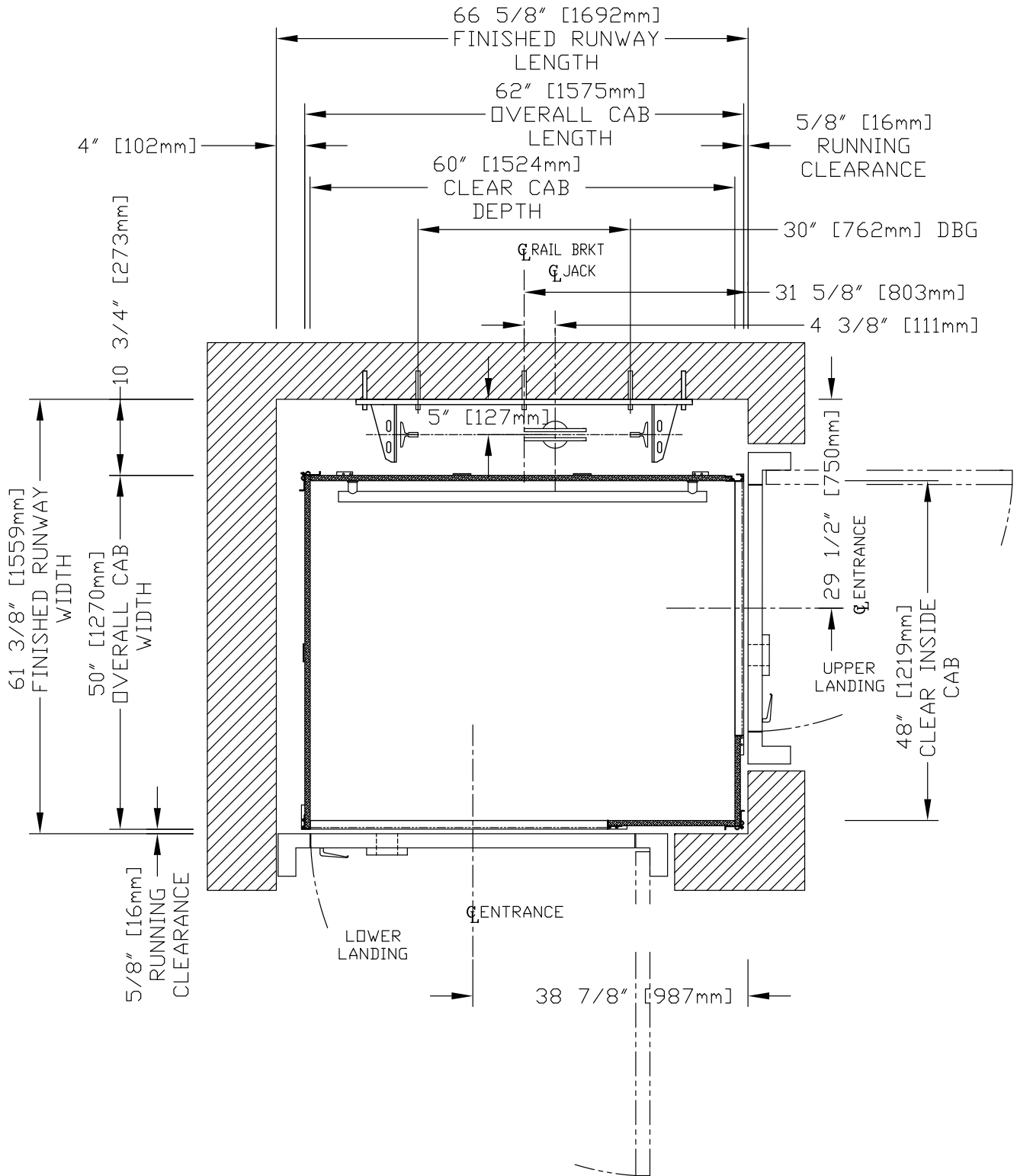

Plan view – Prolift HD type 4 (42" x 54", 42" x 60")

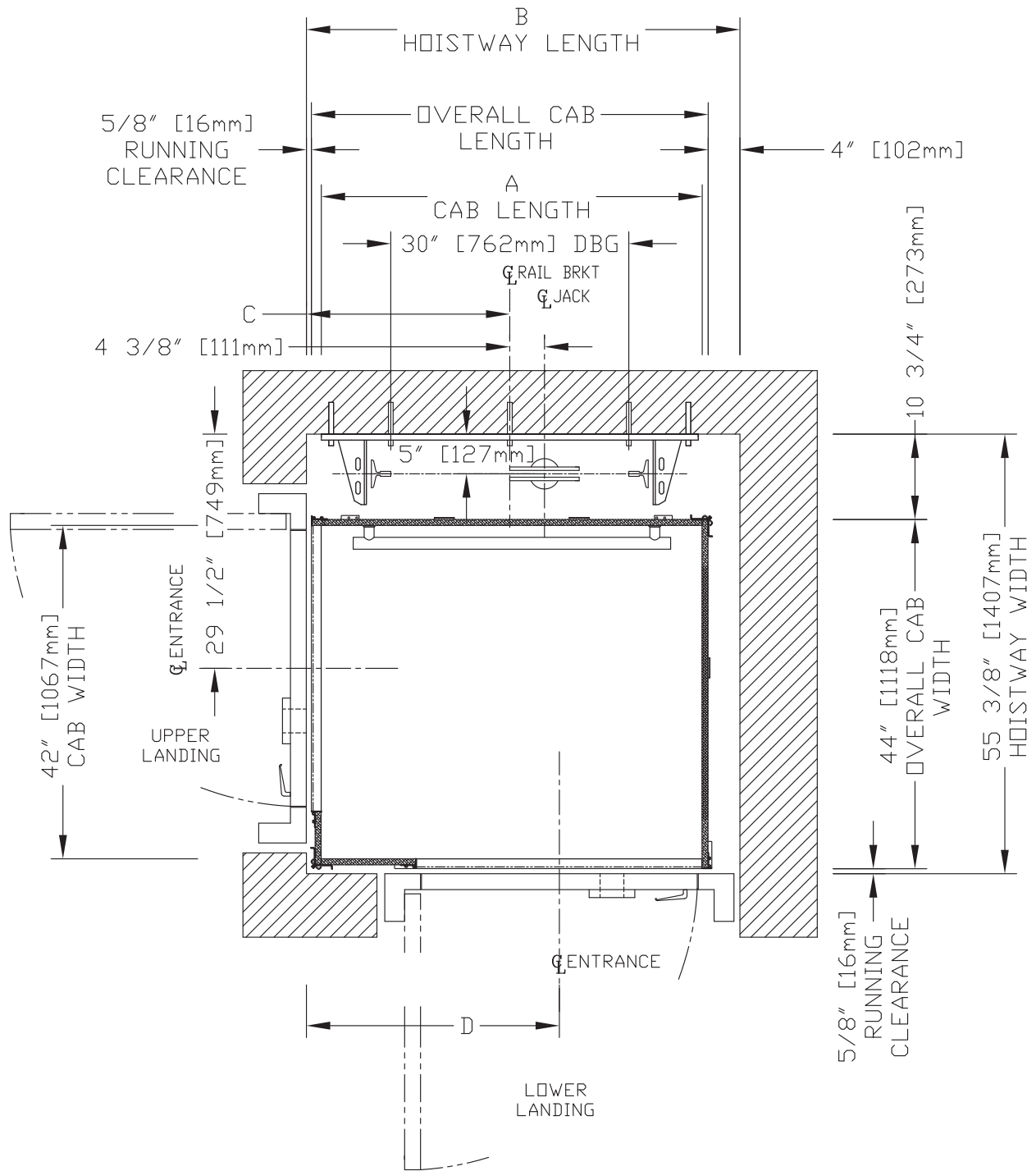

HOISTWAY DIMENSIONS

A CAB LENGTH		B HOISTWAY LENGTH		C RAIL BRKT CENTER LINE		D ENTRANCE CENTER LINE	
mm	Inches	mm	Inches	mm	Inches	mm	Inches
1372	54	1540	60 5/8	727	28 5/8	962	37 7/8
1524	60	1692	66 5/8	803	31 5/8	1114	43 7/8

Plan view – Prolift HD type 4 (48" x 60")

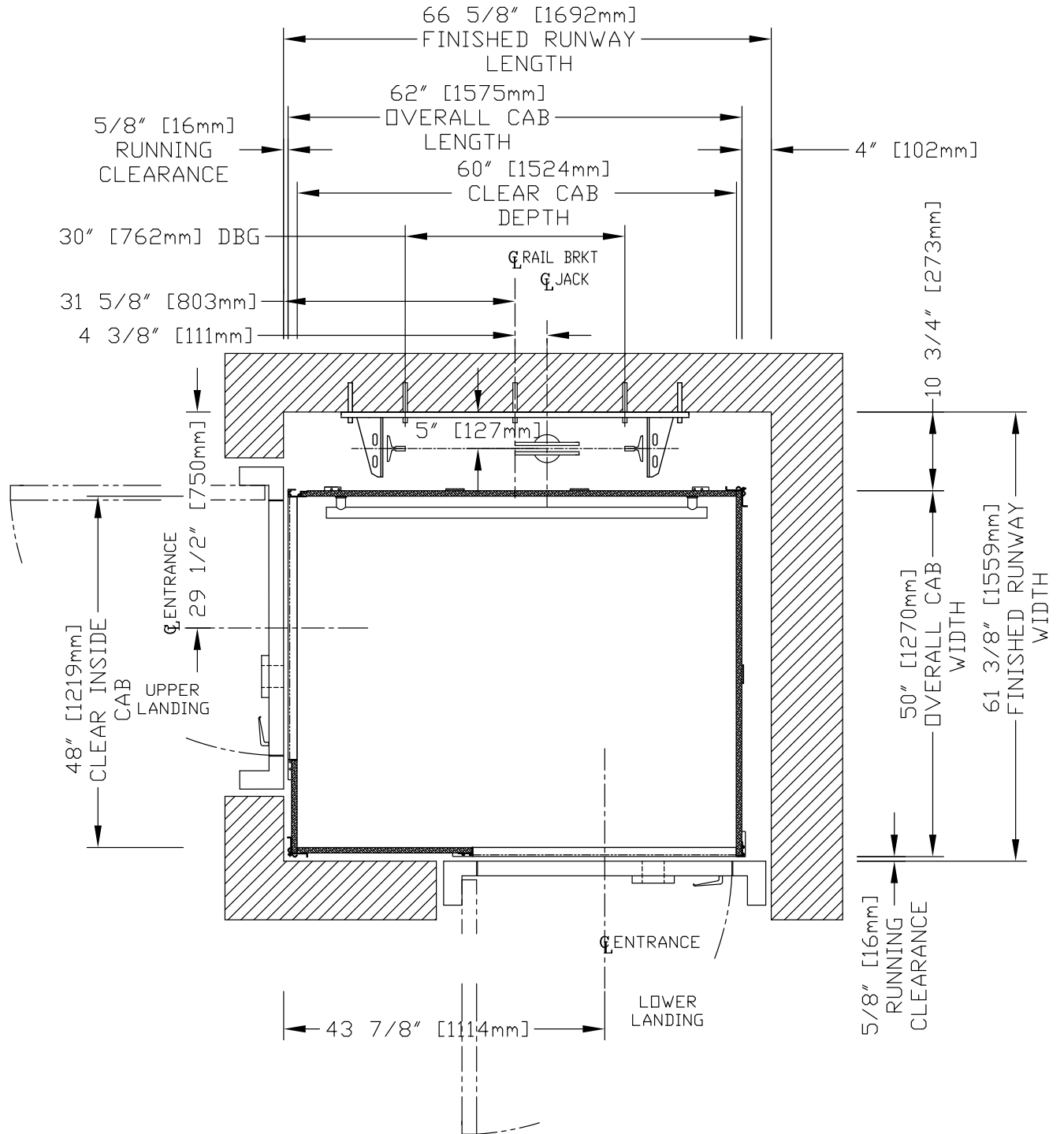

Plan view – Prolift HD type 4 – 42" B wall opening (42" x 54", 42" x 60")

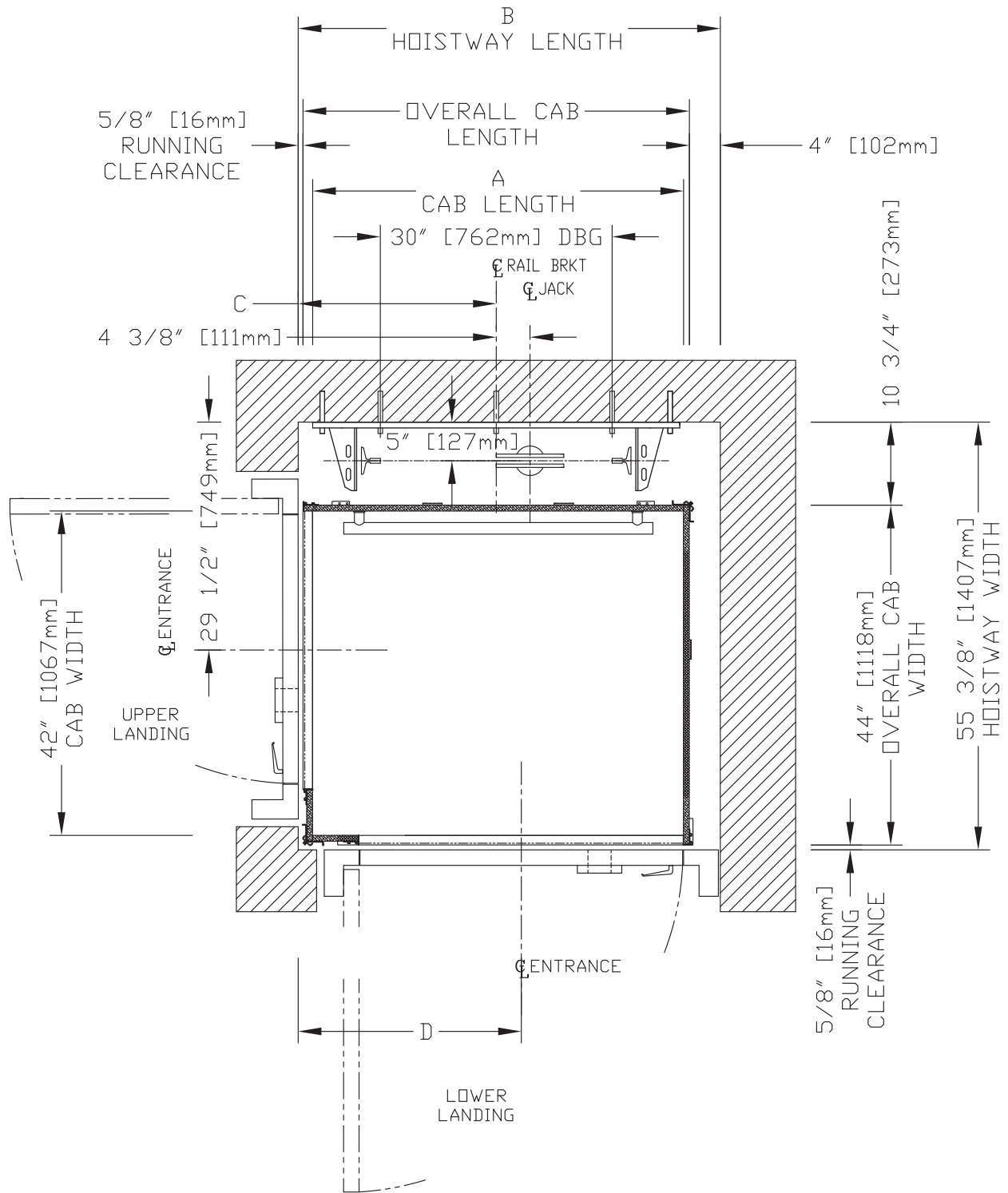

HOISTWAY DIMENSIONS

A CAB LENGTH		B HOISTWAY LENGTH		C RAIL BRKT CENTER LINE		D ENTRANCE CENTER LINE	
mm	Inches	mm	Inches	mm	Inches	mm	Inches
1372	54	1540	60 5/8	727	28 5/8	886	34 7/8
1524	60	1692	66 5/8	803	31 5/8	1038	40 7/8

Plan view – Prolift HD type 4 – 42" B wall opening (48" x 60")

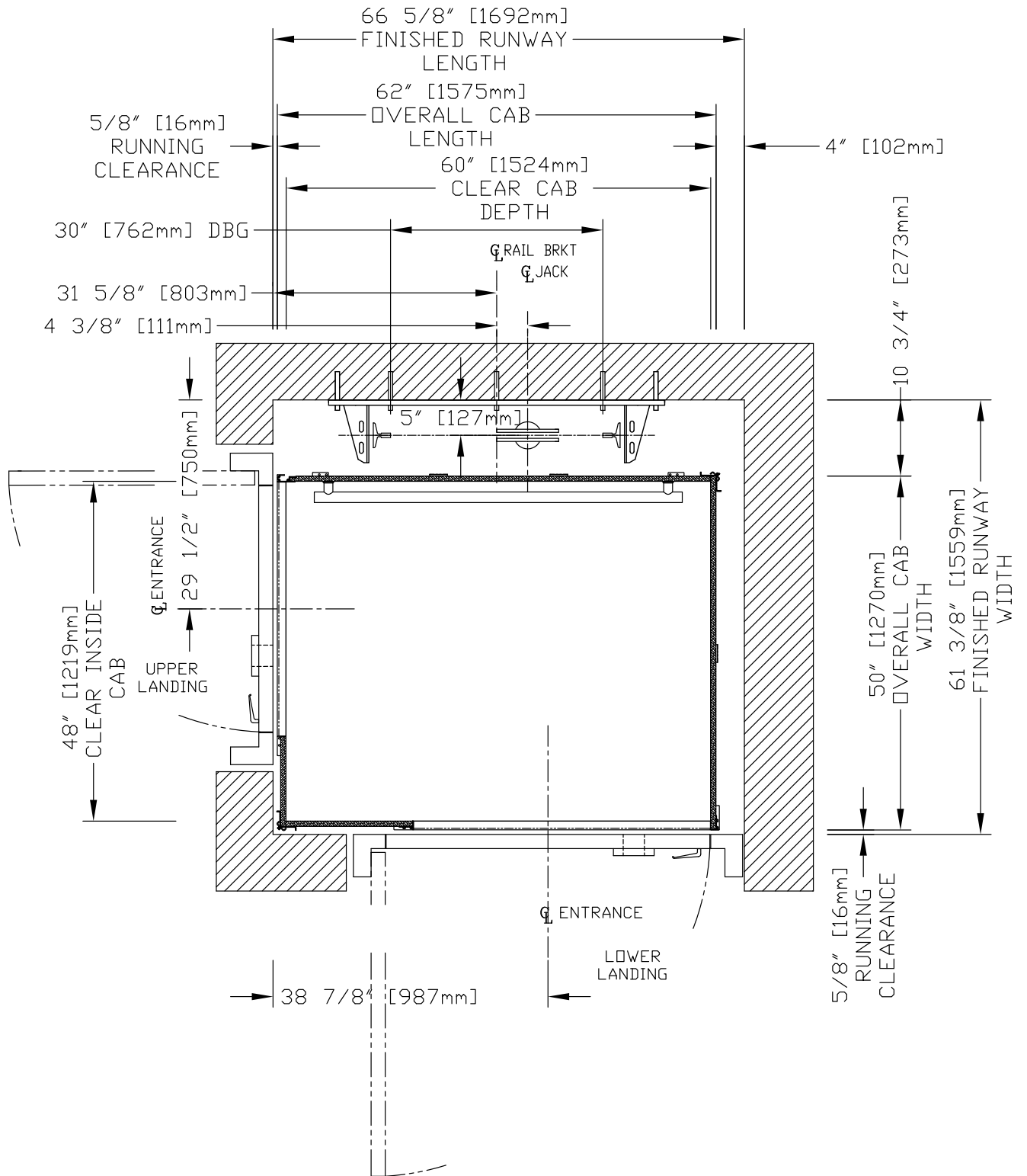

Plan view – Prolift HD type 5 (42" x 54", 42" x 60")

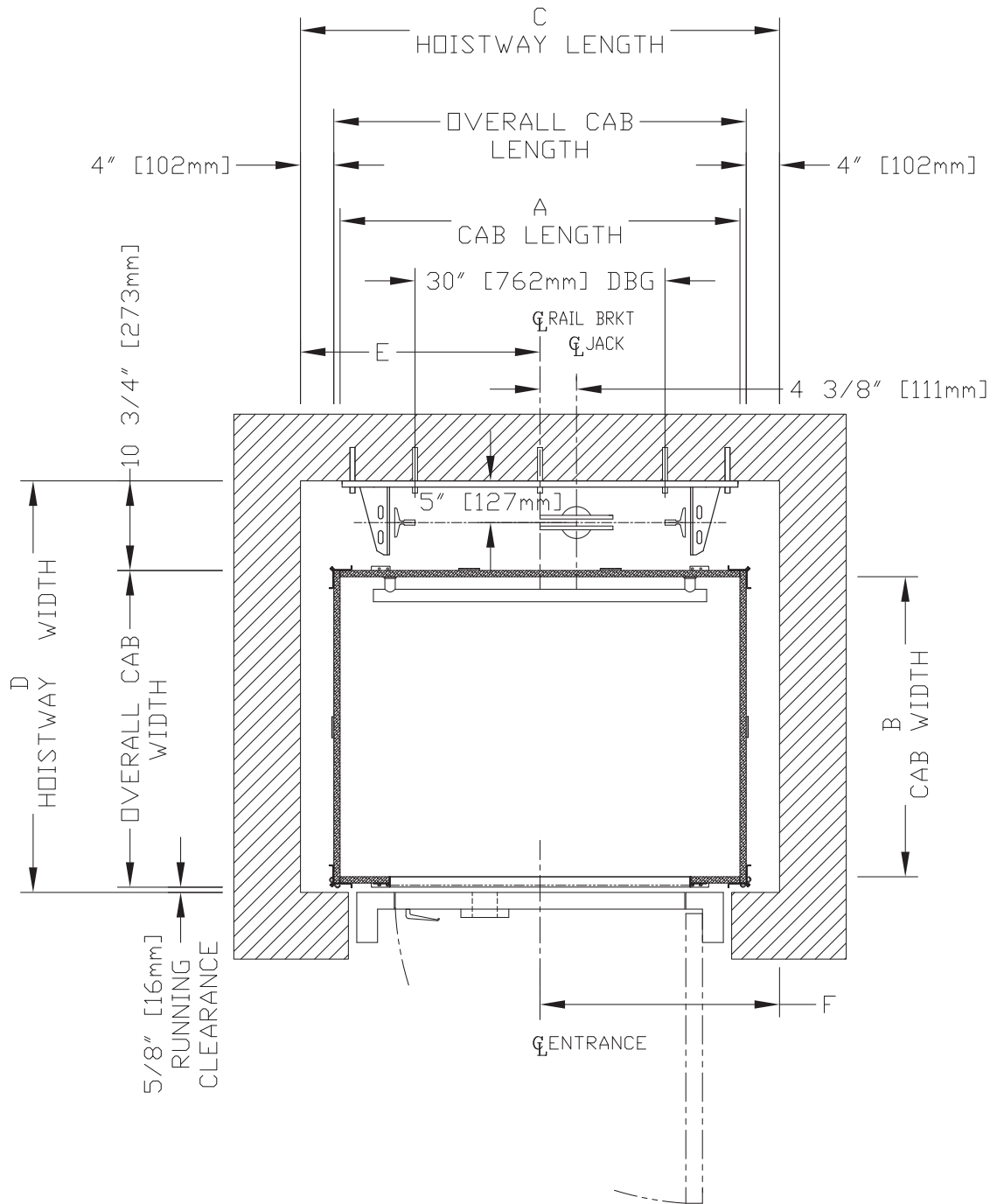

HOISTWAY DIMENSIONS

A CAB LENGTH		B CAB WIDTH		C HOISTWAY LENGTH		D HOISTWAY WIDTH		E RAIL BRKT CENTER LINE		F ENTRANCE CENTER LINE	
mm	Inches	mm	Inches	mm	Inches	mm	Inches	mm	Inches	mm	Inches
1372	54	1067	42	1613	63 1/2	1407	55 3/8	806	31 3/4	806	31 3/4
1524	60	1067	42	1765	69 1/2	1407	55 3/8	883	34 3/4	883	34 3/4

Plan view - Prolift HD type 5 (48" x 60")

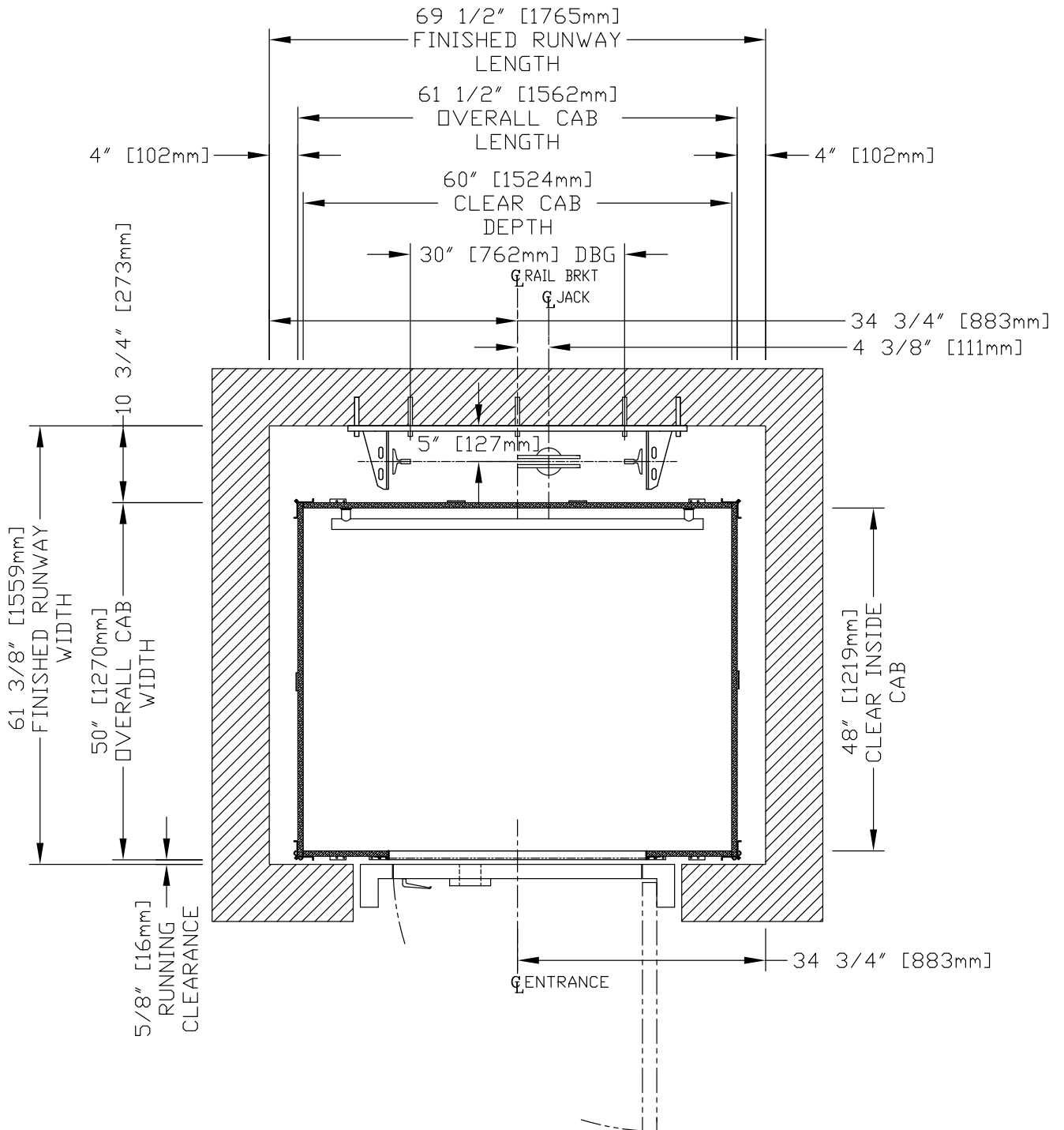

Prodoor auto, left-hand

NOTES:

A) DRYWALL OR PARGING (BY OTHERS) AS REQ'D.

B) SEE DATASHEET OF THE INSTALLATION DRAWING FOR LANDING ENTRANCE SCHEDULE AND RUNNING CLEARANCE.

C) ALL INFORMATION IS SUBJECT TO CHANGE.

GENERAL INFORMATION:

- EACH LANDING ENTRANCE SHALL BE SUPPLIED AS A FINISHED ASSEMBLY WITH DOOR AND FRAME BLANKED, REINFORCED, DRILLED AND TAPPED FOR ALL COMPONENTS DETAILED, READY FOR INSTALLATION.
- FRAMES SHALL BE 16 GA., FULLY WELDED CONSTRUCTION WITH ALL WELDED JOINTS GROUND TO A SMOOTH, UNIFORM FINISH.
- DOORS SHALL BE 18 GA., 2" THICK, SWINGING, FLUSH, STEEL REINFORCED CONSTRUCTION COMPLETE WITH GLASS LITE(S) AS INDICATED.
- DOORS/FRAMES TO BE FABRICATED FROM ZINC PIPE COATED GALVANIZED STEEL WITH ZINC RICH PRIMER, FACTORY APPLIED TOUCH-UP AT THOSE AREA WHERE COATING HAS BEEN REMOVED DUE TO WELDING/GRINDING.
- UL/ULC LABELLED ENTRANCES PROVIDED AS INDICATED 1 1/2 HOURS RATED.
- AUTO DOOR OPERATOR IS PROVIDED & INSTALLED IN THE HEADER.

HORIZONTAL SECTION

FRONT VIEW

ALTERNATE MOUNTING

DRY WALL

CONCRETE

LEFT HAND SWING

PRODOOR 36" AUTOMATIC LH

CUSTOMER:

PROJECT:

ADDRESS:

DATE: MM/DD/YY

ISSUED BY: MM/DD/YY

DATE: MM/DD/YY

BY: [Signature]

Part No. _____

Version No. _____

savaria

JOB No. _____

SHEET No. **1** OF **1**

JOB NUMBER 1 OF 1

Prodoor auto, right-hand

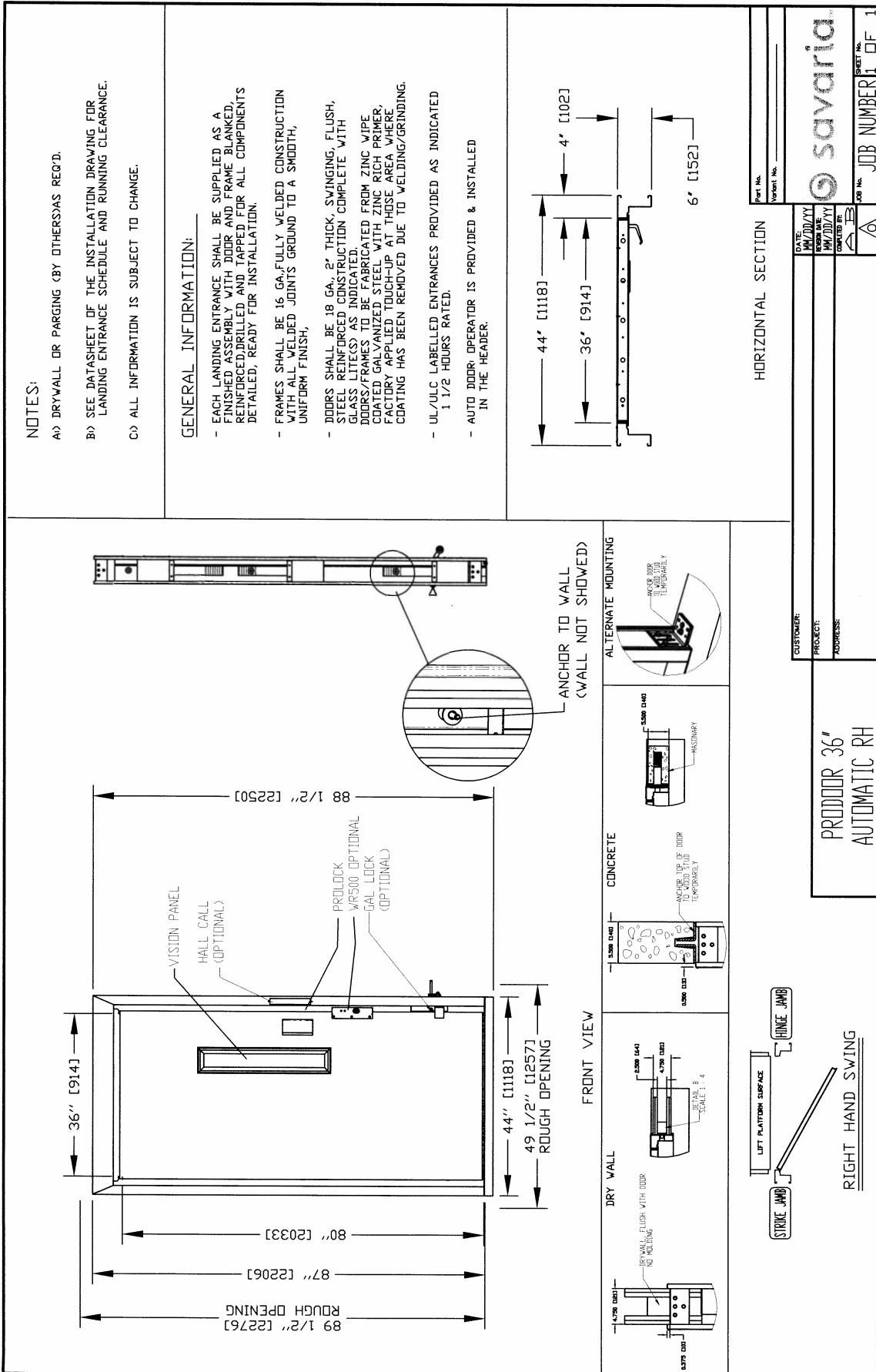

Prodoor manual, left-hand

NOTES:

- A) DRYWALL OR PARGING (BY OTHERS) AS REQ'D.
- B) SEE DATASHEET OF THE INSTALLATION DRAWING FOR LANDING ENTRANCE SCHEDULE AND RUNNING CLEARANCE.
- C) ALL INFORMATION IS SUBJECT TO CHANGE.

GENERAL INFORMATION:

- EACH LANDING ENTRANCE SHALL BE SUPPLIED AS A FINISHED ASSEMBLY WITH DOOR AND FRAME BLANKED, REINFORCED, DRILLED AND TAPPED FOR ALL COMPONENTS DETAILED, READY FOR INSTALLATION.
- FRAMES SHALL BE 16 GA. FULLY WELDED CONSTRUCTION WITH ALL WELDED JOINTS GROUND TO A SMOOTH, UNIFORM FINISH.
- DOORS SHALL BE 18 GA., 2" THICK, SWINGING, FLUSH, STEEL REINFORCED CONSTRUCTION COMPLETE WITH GLASS LITE(S) AS INDICATED.
- DOORS/FRAMES TO BE FABRICATED FROM ZINC PIPE COATED GALVANIZED STEEL WITH ZINC RICH PRIMER, FACTORY APPLIED TOUCH-UP AT THOSE AREA WHERE COATING HAS BEEN REMOVED DUE TO WELDING/GRINDING.
- UL/ULC LABELLED ENTRANCES PROVIDED AS INDICATED 1 1/2 HOURS RATED.
- MANUAL DOOR: HYDRAULIC DOOR CLOSER PROVIDED.

HORIZONTAL SECTION

FRONT VIEW

LEFT HAND SWING

HINGE JAMB

STRIKE JAMB

CUSTOMER: _____

PROJECT: PRODOOR 36" MANUAL LH

ADDRESS: _____

Part No. _____

Variant No. _____

DATE: _____

REV: _____

DATE: _____

REV: _____

DATE: _____

REV: _____

HORIZONTAL SECTION

JOB NUMBER 1 OF 1

Prodoor manual, right-hand

NOTES:

- A) DRYWALL OR PARGING (BY OTHERS) AS REQ'D.
- B) SEE DATASHEET OF THE INSTALLATION DRAWING FOR LANDING ENTRANCE SCHEDULE AND RUNNING CLEARANCE.
- C) ALL INFORMATION IS SUBJECT TO CHANGE.

GENERAL INFORMATION:

- EACH LANDING ENTRANCE SHALL BE SUPPLIED AS A FINISHED ASSEMBLY WITH DOOR AND FRAME BLENDED, REINFORCED, DRILLED AND TAPPED FOR ALL COMPONENTS DETAILED, READY FOR INSTALLATION.
- FRAMES SHALL BE 16 GA., FULLY WELDED CONSTRUCTION WITH ALL WELDED JOINTS GROUND TO A SMOOTH, UNIFORM FINISH.
- DOORS SHALL BE 18 GA., 2" THICK, SWINGING, FLUSH, STEEL REINFORCED CONSTRUCTION COMPLETE WITH GLASS LITE(S) AS INDICATED.
- DOORS/FRAMES TO BE FABRICATED FROM ZINC WIRE COATED GALVANIZED STEEL WITH ZINC RICH PRIMER, FACTORY APPLIED TOUCH-UP AT THOSE AREA WHERE COATING HAS BEEN REMOVED DUE TO WELDING/GRINDING.
- UL/ULC LABELLED ENTRANCES PROVIDED AS INDICATED 1 1/2 HOURS RATED.
- MANUAL DOOR: HYDRAULIC DOOR CLOSER PROVIDED.

HORIZONTAL SECTION

FRONT VIEW

ALTERNATE MOUNTING

DRY WALL

CONCRETE

LEFT PLATE/SURFACE

HINGE JAMB

STRIKE JAMB

RIGHT HAND SWING

CUSTOMER: _____

PROJECT: PRODOOR 36" MANUAL RH

ADDRESS: _____

DATE: MM/DD/YY

REVISED: MM/DD/YY

DESIGNED BY: _____

CHECKED BY: _____

Part No. _____

Sheet No. _____

Part No. _____

Sheet No. _____

JOB NUMBER 1 OF 1

Prodoor installation (drywall)

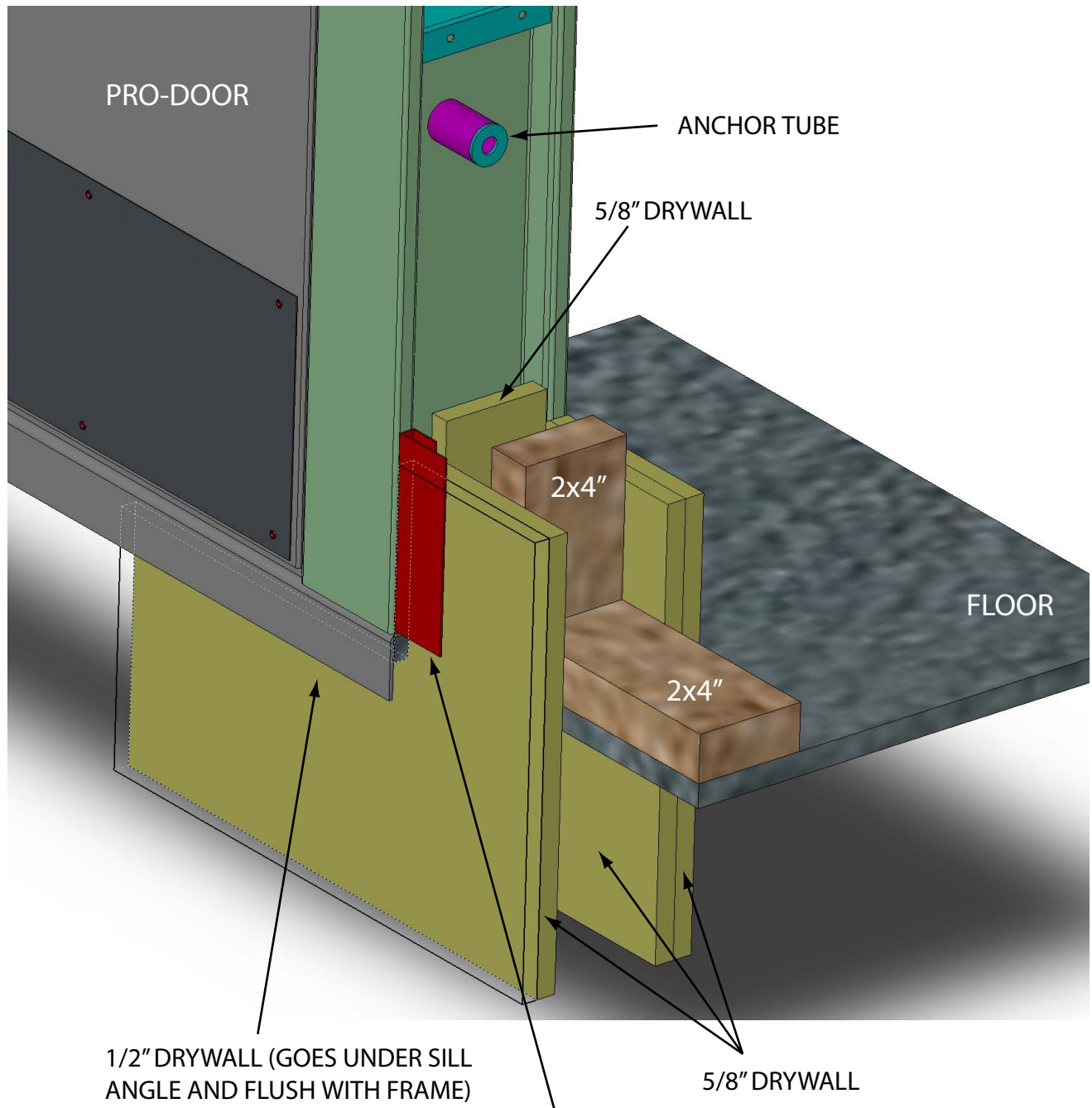

NOTE: USE EITHER A J-CHANNEL OR L-SHAPED CORNER BEAD ON EDGE OF DRYWALL FOR REINFORCEMENT.

Other door and gate specifications

For other door and gate specifications, go to our website www.savaria.com, select the “architects and builders” tab at the top of the page and then select “Doors and Gates” from the menu on the left-hand side of the page.

The link is as follows: <http://www.savaria.com/architects/drawings/doors-gates/index.php>.

Loads on building

RAIL FORCES		
*R1	*R2	CAPACITY
422. lbf.	251.50lbf.	1400 lbs.
355.03lbf.	251.50lbf.	1000 lbs.
RAIL WEIGHT : 8.0 lbs / ft		

R3 NOTE:	
PIT FLOOR TO SUPPORT LOAD OF: * (INCLUDES IMPACT)	
CAPACITY	
8.22 Kips	1400 lbs.
6.4 Kips	1000 lbs.

FOR TOTAL PULL-OUT FORCE ON RAIL BRACKET, R1 MUST BE DOUBLED eg. 608 lbf for 1000 lbs.

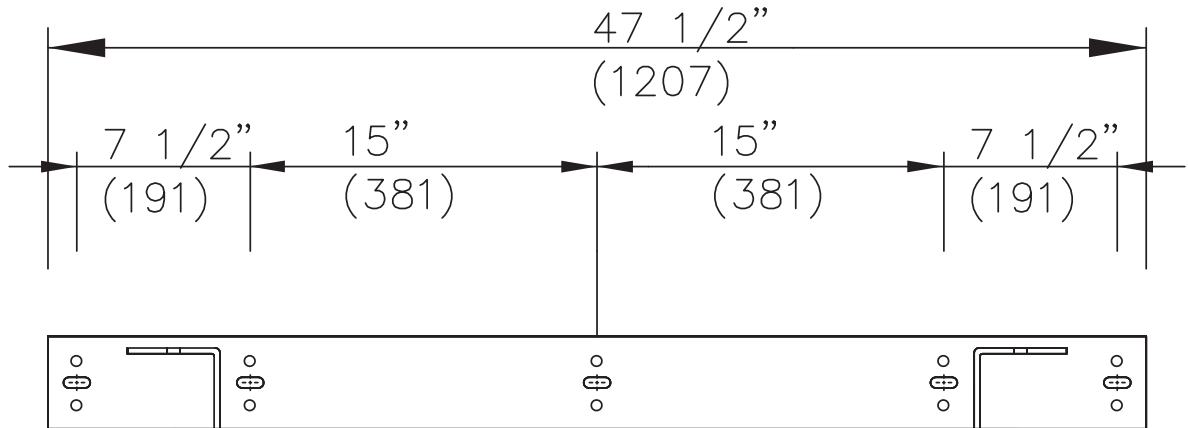
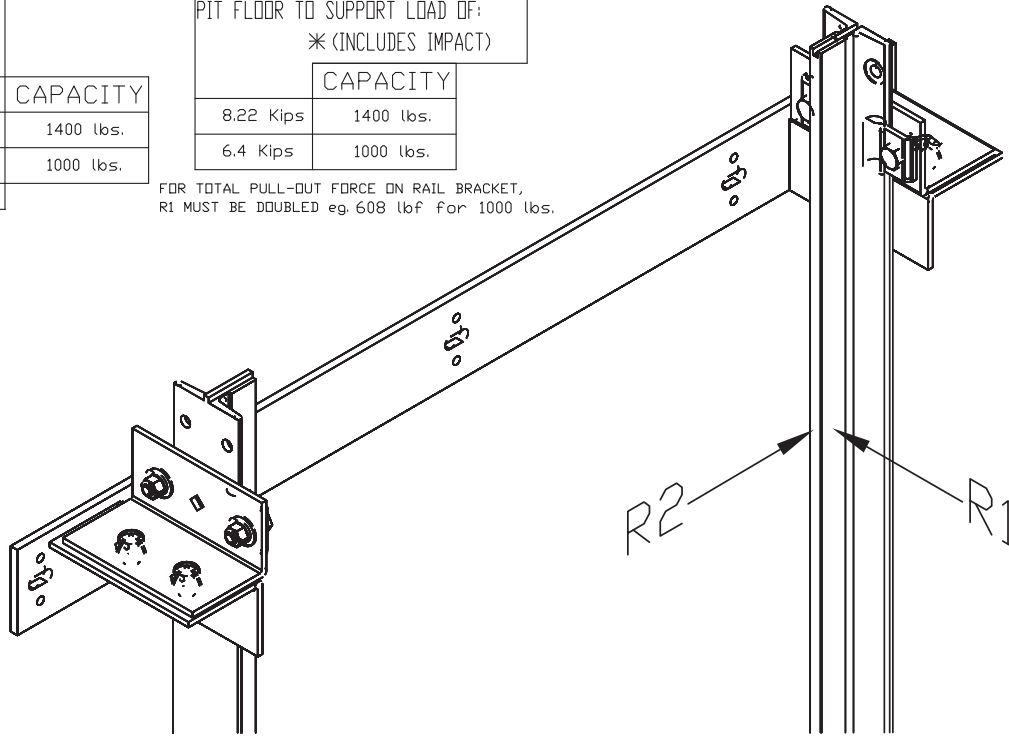

Rail bracket dimensions

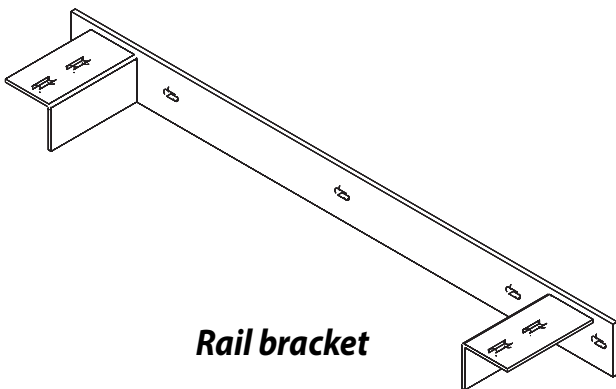

Rail bracket

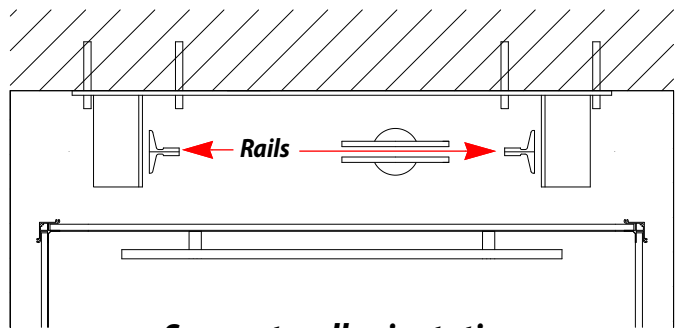

Support wall orientation

Pit details

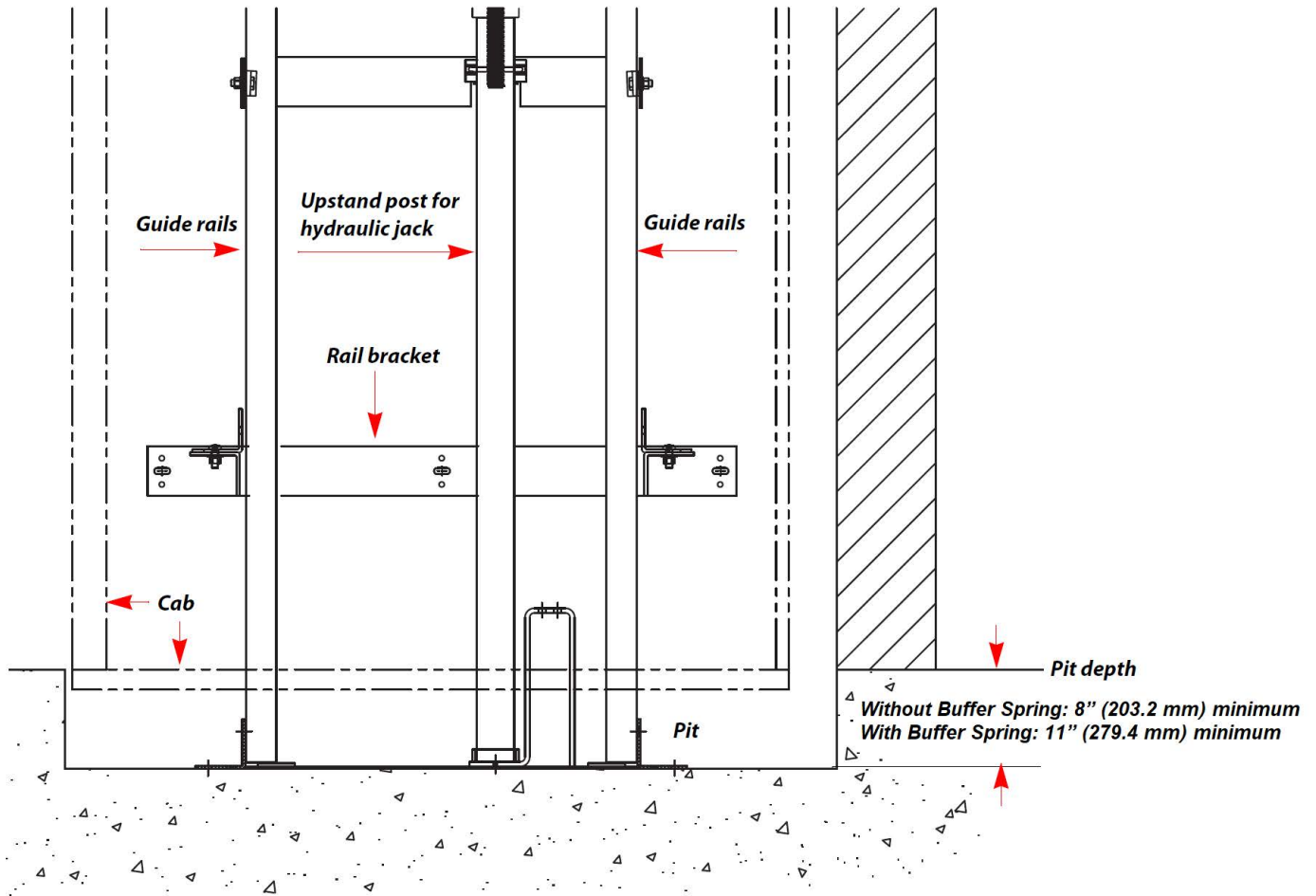

Hoistway and pit notes

- A load bearing wall is required to sustain rail reactions (refer to the section “Loads on building” on the previous page).
- Suggested hoistway pit floor construction consists of an 8” (203 mm) concrete slab poured on a natural or compacted soil with a minimum allowable bearing pressure of 1.0 KSF.
- The minimum compressive strength of the concrete at 28 days must be no less than 3000 PSI. #5 reinforcing steel (grade 60) must be placed at the bottom of the slab in two traverse directions and at a spacing of 12” (305 mm).
- Hoistway sizes reflect running and access clearances only. Consult your local AHJ to assure compliance with local codes.
- Hoistway is required to be free of all pipes, wiring and obstructions not related to the operation of the elevator.

Masonry construction – sectional view

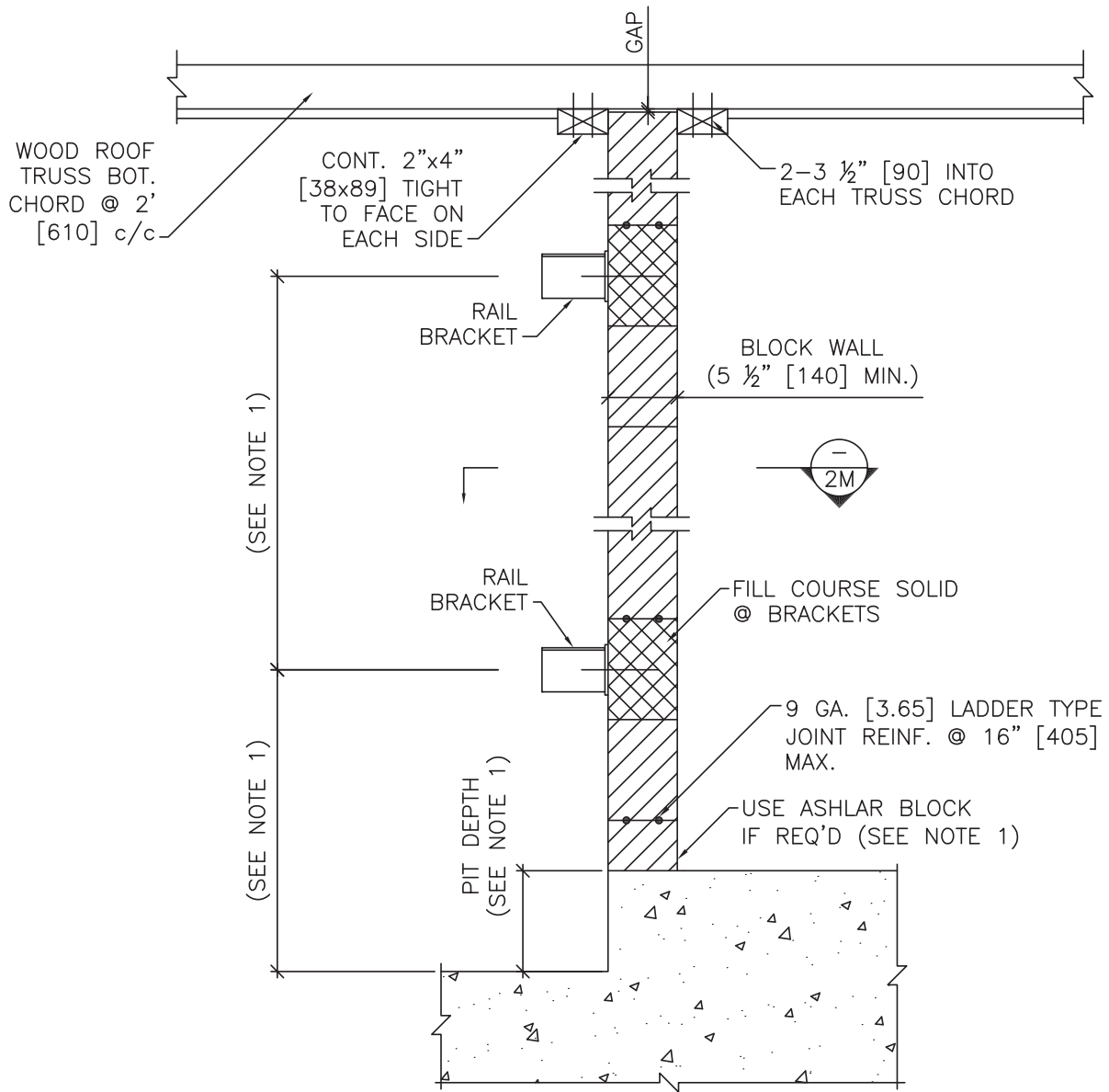

Masonry construction – plan view

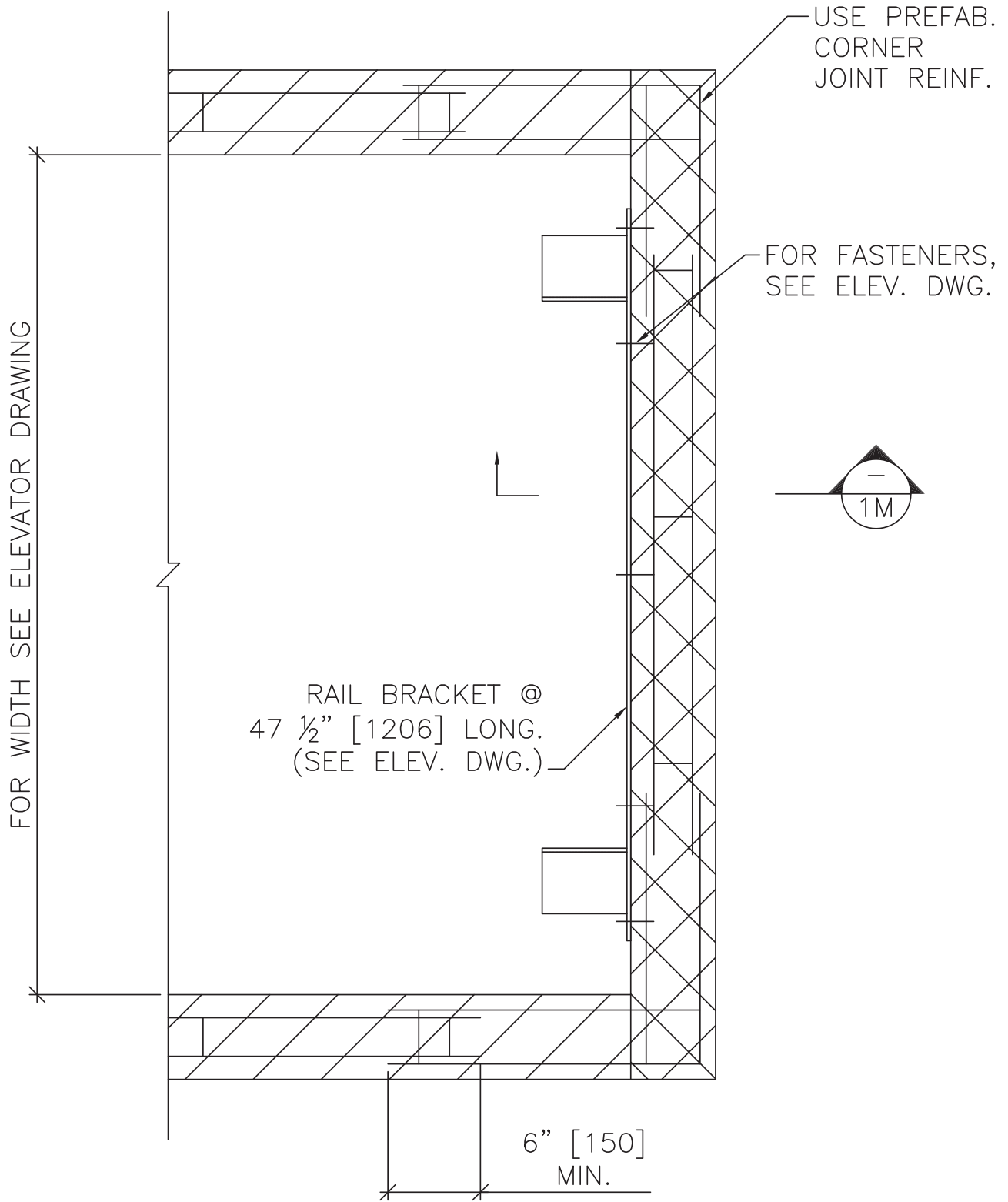

Wood construction – sectional view

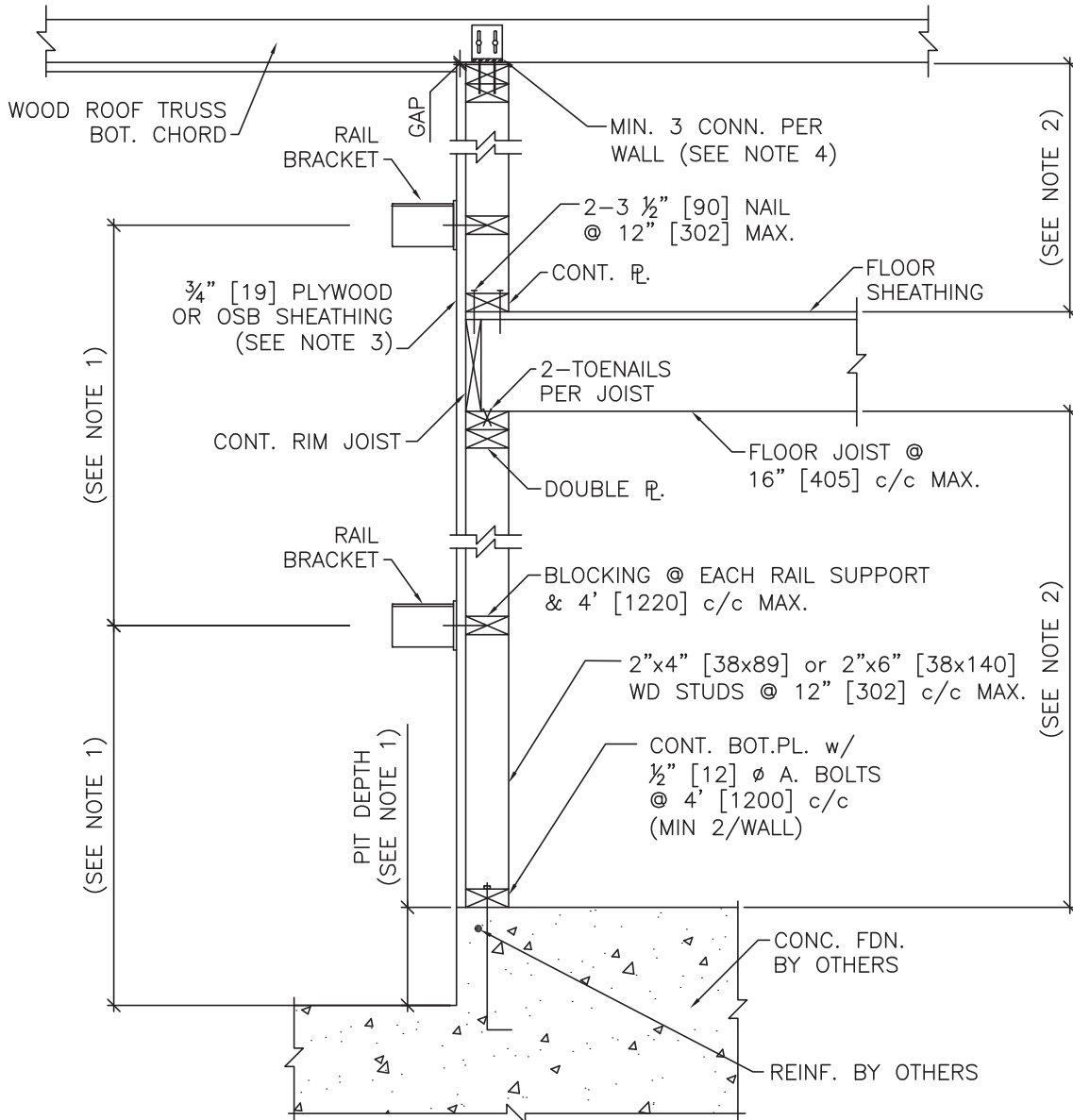

For Reference Only

Wood Stud Partitions (Load-Bearing) – 2-Hour Rating

<p>152 mm 6"</p> <p>wt. 59 kg/m² (12 PSF)</p>	<p>Wd Stud—2 layers 15.9 mm (5/8") SHEETROCK brand gypsum panels, FIRECODE core, or SHEETROCK brand gypsum panels, water-resistant, FIRECODE core, or SHEETROCK Vinyl-Faced Gypsum Panels, FIRECODE Core, ea side—2x4 400 mm (16") o.c.—base layer att with 48 mm (1 1/2") nails 150 mm (6") o.c.—face layer att with 60 mm (2 3/8") nails 200 mm (8") o.c.—joints fin—ULC Des U301, UL Des U301</p>	<p>N/A</p>	<p>SA924 SA928</p>	<p>101</p>
<p>152 mm 6"</p> <p>wt. 59 kg/m² (12 PSF)</p>	<p>Wd Stud—2 layers 15.9 mm (5/8") SHEETROCK brand gypsum panels, FIRECODE C core, ea side—2x4 400 mm (16") o.c.—76 mm (3") THERMAFIBER SAFB—RC-1 chan or equiv one side, spaced 600 mm (24") o.c.—resil side screw att—opp side nail att—both base layers appl vert and face layers appl horiz—resil layers perim caulked—joints fin—UL Des U334</p>	<p>59 TL-67-239</p>	<p>SA924</p>	<p>102</p>
<p>152 mm 6"</p> <p>wt. 63 kg/m² (13 PSF)</p>	<p>Wd Stud—2 layers 15.9 mm (5/8") SHEETROCK brand gypsum panels, FIRECODE C core, ea side—2x4 400 mm (16") o.c.—51 mm (2") THERMAFIBER SAFB—RC-1 chan or equiv one side, spaced 600 mm (24") o.c.—resil side screw att—opp side nail att—both base layers appl vert and face layers appl horiz—resil layers perim caulked—joints fin—UL Des U334</p>	<p>58 USG-810219 52 Based on same assembly (non-fire rated) without SAFB—USG-810218</p>	<p>SA924</p>	<p>103</p>

Wood construction – plan view

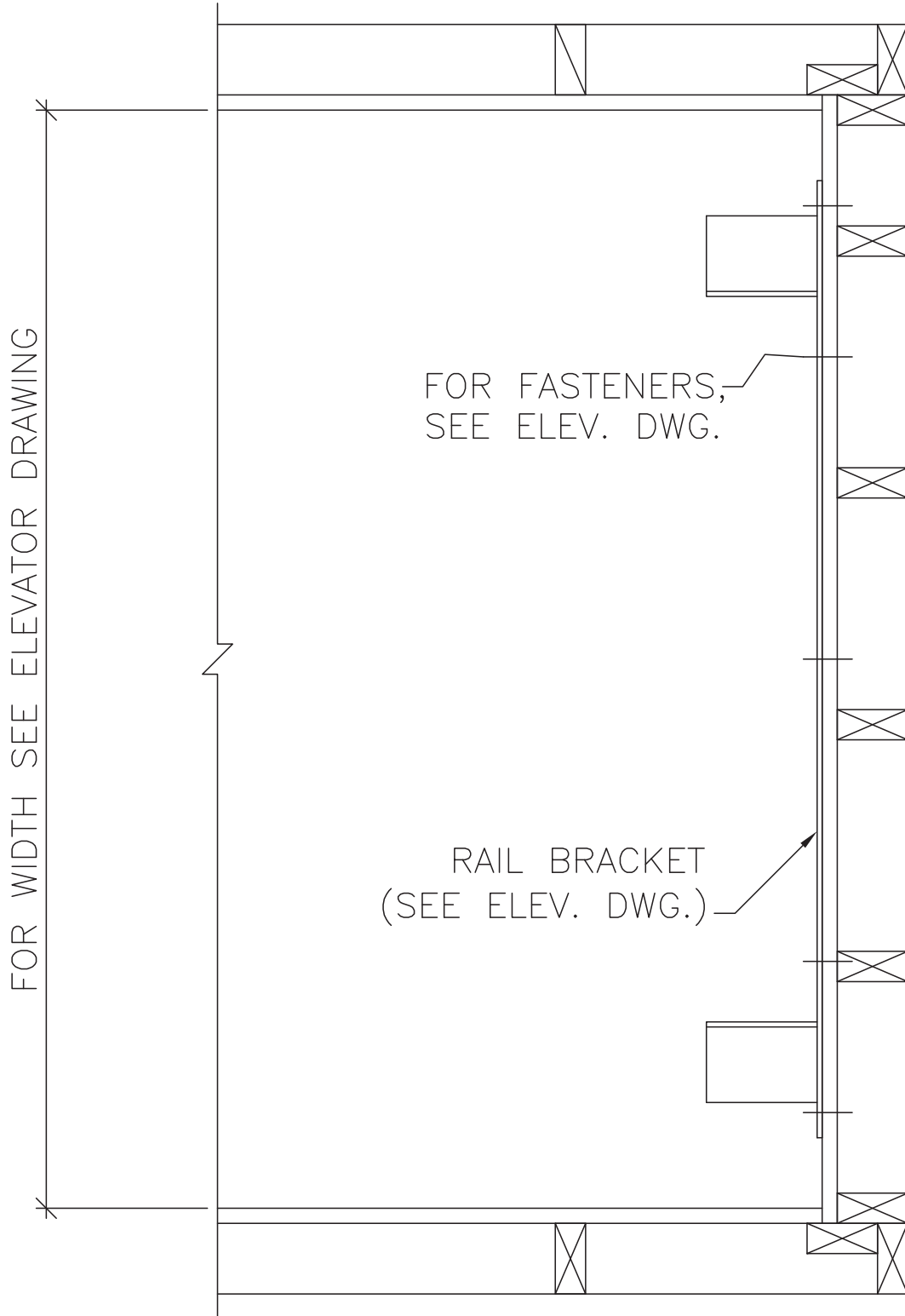

Suggested wall configuration for wood construction

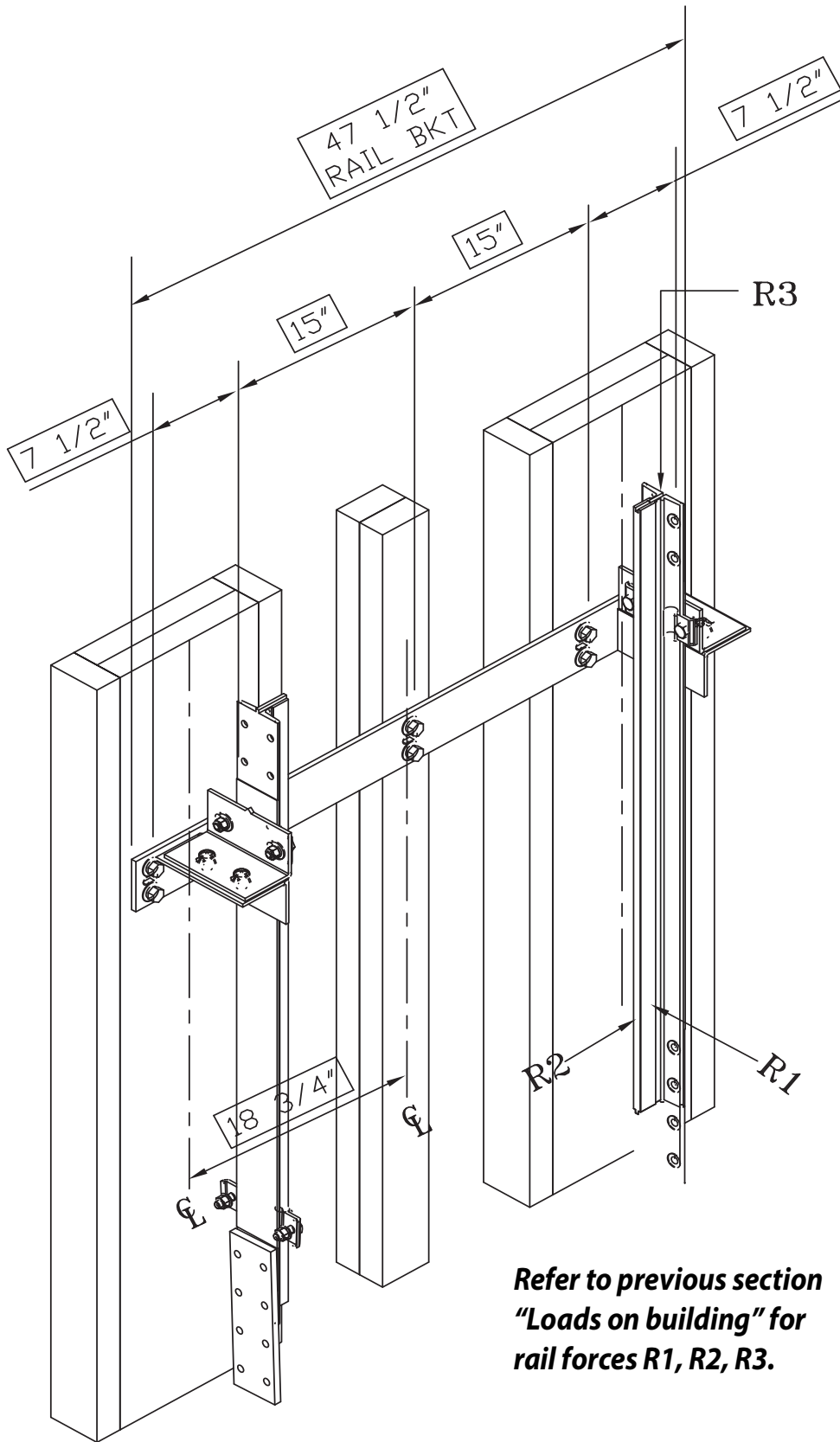

**Refer to previous section
"Loads on building" for
rail forces R1, R2, R3.**

Suggested wall configuration for wood construction

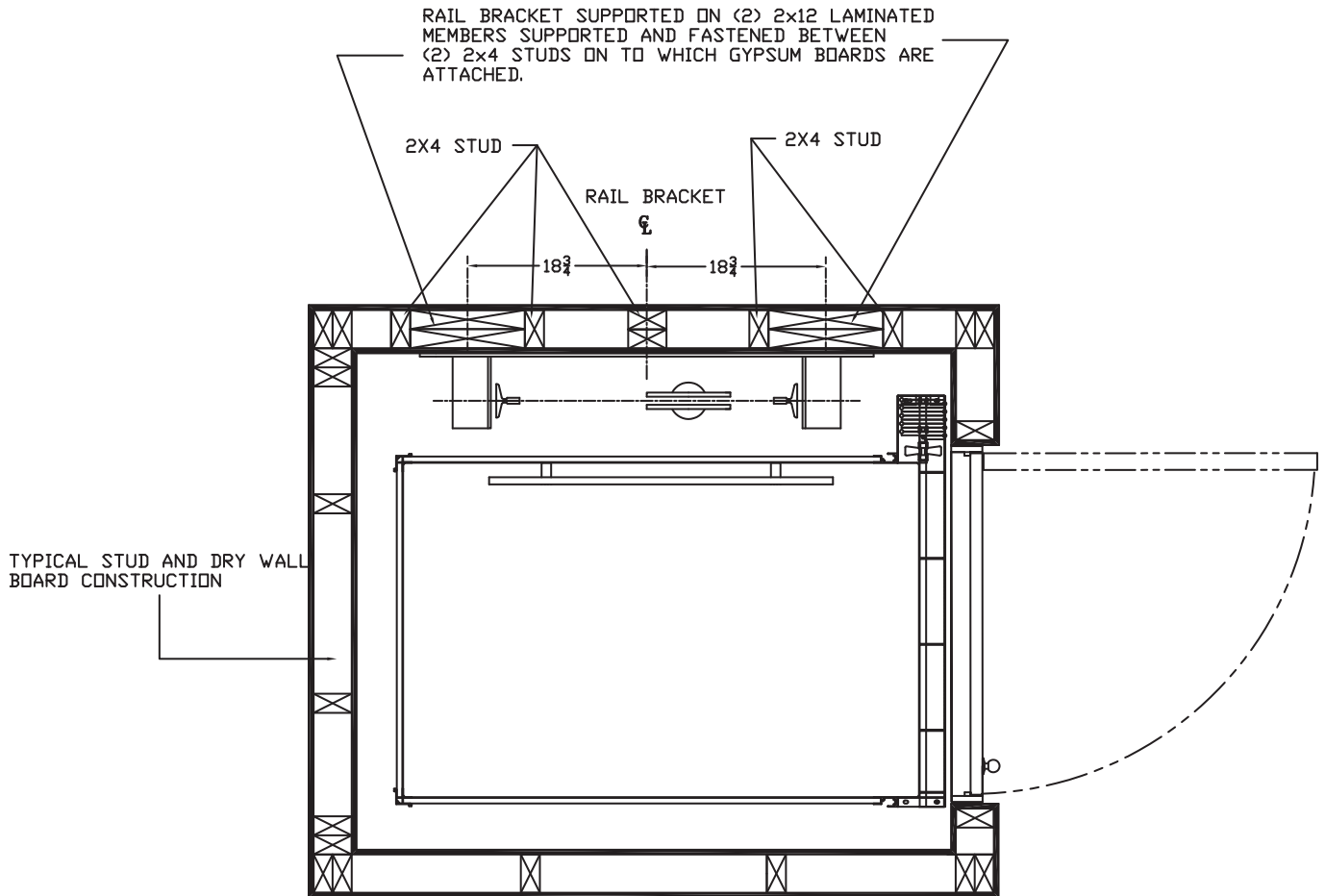

NOTE:

1. THIS DRAWING IS FOR REFERENCE ONLY. BUILDING STRUCTURAL ENGINEER TO ENSURE THAT THE BUILDING AND HOISTWAY WILL SAFELY SUPPORT ALL LOADS IMPOSED BY THE LIFT EQUIPMENT
2. FIRE RATING OF HOISTWAY IS SUBJECT TO LOCAL BUILDING CODES.

Rail support wall specifications

Drawing notes

- 1) See the lift installation (shop) drawings for rail bracket spacing and pit depth.
- 2) Wall lateral support spacing:
 - For 2" x 4" studs, use 6 ft 10" (2090 mm) max.
 - For 2" x 6" studs, use 13 ft 6" (4120 mm) max.
- 3) Sheathing installation: install sheets vertically full width of shaft or min. centred on rail brackets.
- 4) Connectors to resist horizontal load but allow vertical movement. For wood, use 2" x 1/4" cap screw lag bolts.

General specifications

- G1 The design and construction of all work is to conform to the local applicable building code.
- G2 Read the installation (shop) drawings in conjunction with all related architectural, mechanical, electrical, and lift drawings as well as any other contract documents.
- G3 The wall drawings have been prepared using engineering principles and the design loads that are applied by the lift rails to the wall. However, the details and member sizes and the attachments to the structure should not be construed as a complete design of the wall system. The contractor and/or the project engineer is responsible to evaluate the other loads that are applied to the wall from the floor or roof system and modify member sizes or connections as required by their analysis.
- G4 Do not scale the drawings.
- G5 See the lift installation (shop) drawings for service loads (including dynamic effects) which are:
 - Horizontal load parallel to the wall
 - Horizontal load perpendicular to the wall
- G6 Wood: SPF NO 1/2 Mix
 Concrete: 3000 psi (20 Mpa) @ 28 days. If exposed use 5% to 7% air content.
 Anchor bolts: ASTM A307
 Mortar: Type "S"
 Masonry grout: 2100 psi (14 Mpa) high slump
 Masonry block: 2100 psi (14 Mpa) on net area
- G7 Wall to be installed plumb and square within 1/8" (3 mm) of top and bottom of shaft.
- G8 Wall lateral support spacing (H) selected for maximum horizontal deflection of H/360 from rail loads.

Wood construction

- W1 Separate wood from concrete with waterproof barrier or use pressure treated wood.
- W2 Bridging maximum spacing: Load bearing or shear walls – 4 ft c/c
- W3 Nail or screw sheathing at 6" c/c at edges and 12" c/c to other members.
Use 2.5" standard Ardox nails or 2" #12 screws.

Masonry construction

- M1 All masonry construction to conform to applicable local standards
- M2 Reinforce lintel blocks with 2 m-15 m bottom bars unless noted.
- M3 Provide continuous ladder type joint reinforcement at 16" (400) c/c.

Provisions by others

Hoistway

The hoistway must be designed and built in accordance with all applicable codes (identified on the cover of this manual) and all state and local codes.

Due to close running clearances, owner/agent must ensure that hoistway and pit (where provided) are level, plumb and square and are in accordance with the dimensions on the installation drawings.

Minimum overhead clearance

Owner/agent must ensure minimum overhead clearance is in compliance with codes.

Construction site

Owner/agent to provide all masonry, carpentry and drywall work as required and shall patch and make good (including finish painting) all areas where walls/floors may need to be cut, drilled or altered in any way to permit the proper installation of the lift.

Dimensions

Contractor/customer to verify all dimensions and report any discrepancies to our office immediately.

Structural

Structural engineer to assure that building and shaft will safely support all loads imposed by the lift equipment. Refer to the tables on installation drawings for loads imposed by the equipment.

Entrance assemblies must be adjusted to align with platform and interlock equipment. Others to allow an adequate rough opening.

Return walls at entrances must be built-in by others after entrance assemblies are in place. Entrance assembly must be securely fastened to walls by elevator contractor.

Entrances

Fascia panel below upper level entrance where required. Fascia panel must be fastened to a solid wall and be perpendicular to the floor and walls. Hoistway fascia is not self-supporting for long, continuous runs void of entrances. Adequate support for the fascia must be provided.

Machine room

Machine room must be located at the lowest level adjacent to hoistway, unless shown otherwise on the installation drawings. Field adjustment by installer may be necessary to meet job site conditions or regulations. Access to machine room to be through self-closing lockable door.

Sleeves for oil and electric lines must be provided from machine room to runway as required (positioned per installer's instructions).

Electrical

Power supply with a lockable fused disconnect and auxiliary contact to break the battery feed, or circuit breakers with a 3-pole breaker for battery feed required, in compliance with electrical code, located on wall on lock jamb side of machine room door. Contact your Savaria dealer or refer to one of the tables on the next page for OEM part numbers.

Permanent power of 208 volts, three-phase, 30 amps or 230 volts, single-phase, 40 amps must be supplied by others before installation begins.

Owner/agent to ensure at least 9.3 foot-candles (100 lux) ambient lighting over lift area.

Remote hall call (when supplied) to be installed by the owner/agent at 42" from landing floor.

For Prolift SCL (3 HP pump unit)

Disconnect Switch Types & Accessories	Cutler Hammer	Federal Pioneer	Siemens
1 Phase 3 H.P. Pump Unit			
2 Pole 240V 1 PH	1HD221N	1322SN	ID321
Required Auxiliary Contact	DS16CP	E1K-1AEV-W94	MSSAK 116
Required Type "D" Fuse (Buss type "FRN" or equal)	2@30 amp	2@30 amp	2@30 amp
3 Phase 3 H.P. Pump Unit			
3 Pole 208V 3 PH	1HD321N	1332SN	ID321
Required Auxiliary Contact	DS16CP	E1K-1AEV-W94	MSSAK 116
Required Type "D" Fuse (Buss type "FRN" or equal)	3@20 amp	3@20 amp	3@20 amp
Cab Lighting			
1 Pole Solid Neutral 120V 1 PH	GP 111N	86211	CFN 211
Required Type "D" Fuse (Buss type "T" or equal)	1@15 amp	1@15 amp	1@15 amp

For Prolift HD (5 HP pump unit)

Disconnect Switch Types & Accessories	Cutler Hammer	Federal Pioneer	Siemens
1 Phase 5 H.P. Pump Unit			
2 Pole 240V 1 PH	1HD222N	1322SN	ID321
Required Auxiliary Contact	DS16CP	E1K-1AEV-W94	MSSAK 116
Required Type "D" Fuse (Buss type "FRN" or equal)	2@40 amp	2@40 amp	2@40 amp
3 Phase 5 H.P. Pump Unit			
3 Pole 208V 3 PH	1HD321N	1332SN	ID321
Required Auxiliary Contact	DS16CP	E1K-1AEV-W94	MSSAK 116
Required Type "D" Fuse (Buss type "FRN" or equal)	3@30 amp	3@30 amp	3@30 amp
Cab Lighting			
1 Pole Solid Neutral 120V 1 PH	GP 111N	86211	CFN 211
Required Type "D" Fuse (Buss type "T" or equal)	1@15 amp	1@15 amp	1@15 amp

Find more design resources at:

savaria.com

[CAD drawings](#)

[BIM objects](#)

[SpecWizard](#)

[Continuing education calendar](#)

Savaria Concord Lifts, Inc.
2 Walker Drive Brampton ON L6T 5E1 Canada

Part No. 000781, Rev. 023

 **savaria.**
savaria.com

©2025 Savaria Corporation